



# TESEO

EQUIPAMIENTO INTEGRAL DE OFICINA

Designed by  
ISMOBEL

## CARACTERÍSTICAS TÉCNICAS

### MESAS Y MESAS DE JUNTAS

Sobres de mesa fabricados en tablero bilaminado de 25mm. de espesor o en cristal de seguridad mate de 5+5. Cantos rectos termofusionados de PVC de 2mm. de espesor.

Altura de mesa 740mm., regulable mediante niveladores antideslizantes de 50mm. de diámetro que permiten la regulación de 25mm. en altura.

Patas en forma de U invertida, fabricadas en tubo de acero laminado en frío de sección cuadrada de 50x50x2 mm., y de sección rectangular de 50x25x2 mm. para la parte horizontal que une las patas.

Incorpora doble bastidor metálico fabricado en tubo de acero laminado en frío de sección rectangular de 40x30x1,5 mm. anclado en ambos extremos a las patas.

Acabado de toda la estructura en pintura epoxi color aluminio o blanco.

### PANELES SEPARADORES MADERA

Fabricados en tablero bilaminado de 19 mm. de espesor y para el caso de faldones también se pueden adquirir en chapa de acero de 1 mm. de espesor, acabado en pintura epoxi color aluminio o blanco.

Soportes de faldones y separadores fabricados en chapa de acero, acabado en pintura epoxi color aluminio o blanco.

### ACCESORIOS, BANDEJAS, SEPARADORES METACRILATO, ENCHUFES Y SOPORTE CPU

Mirar características y precios en ACCESORIOS.

### LIBRERÍAS, ARMARIOS, CAJONERAS

Librerías, elementos de archivo, cajoneras, armarios,... se pueden consultar en la sección ALMACENAJE.

## INSTRUCCIONES DE PEDIDO

Para realizar el pedido se deberán sustituir los símbolos de la referencia siguiendo las siguientes instrucciones:

T ● 180 ▲

“ T “ : se refiere a la serie Teseo

“ ● “ : se refiere al acabado de los elementos de melamina. Puede fabricarse en los siguientes colores:

H-haya E-cerezo G-gris R-roble F-grafito S-blanco T-teka O-baco C-arce

Opcionalmente los sobres pueden suministrarse en madera barnizada. Consultar precio.

“ 180 “ : indica la referencia del artículo

“ ▲ “ : se refiere al acabado metálico de las patas. Puede ser: L-aluminio S-blanco

MESAS Y ALAS

A x B

REFERENCIA

P.V.P.(€)

Kg. BUL. M<sup>3</sup>

MELAMINA FENÓLICO ESTRATIFICADO  
BLANCO 13 MM. BLANCO

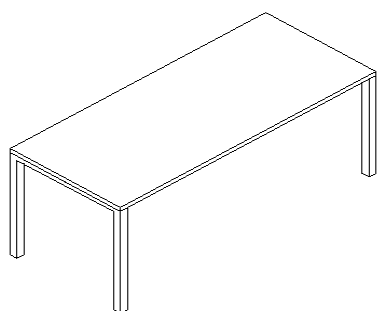

MESA RECTA

PATA CERRADA: + 120 €

	A x B	REFERENCIA	P.V.P.(€)			Kg.	BUL.	M <sup>3</sup>
			MELAMINA	FENÓLICO	ESTRATIFICADO			
Fondo 80 cm.	200x80	T●200▲				41	3	0,18
	180x80	T●180▲				38	3	0,17
	160x80	T●160▲				35	3	0,16
	140x80	T●140▲				32	3	0,15
	120x80	T●120▲				29	3	0,14
Fondo 60 cm.	200x60	T●206▲				34	3	0,15
	180x60	T●186▲				32	3	0,14
	160x60	T●166▲				30	3	0,13
	140x60	T●146▲				28	3	0,12
	120x60	T●126▲				26	3	0,11

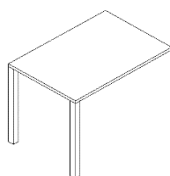

MODULO ALA RECTANGULAR

100x60	T●100A▲	17	3	0,10
80x60	T●80A▲	14	3	0,09

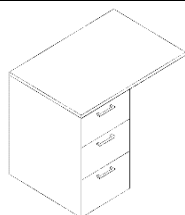

MODULO ALA RECTANGULAR

100x60	T●100A4C	46	2	0,25
100x60	T●100A3C	44	2	0,25
100x60	T●100A3B	44	2	0,25

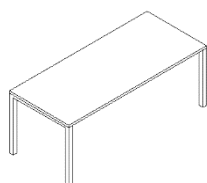

MESA RECTA

PATA CERRADA: + 120 €

180x80	T 180 Cr▲	58	3	0,17
160x80	T 160 Cr▲	54	3	0,16
140x80	T 140 Cr▲	50	3	0,15

SOBRE CRISTAL DE SEGURIDAD MATE 5+5. CONSULTAR PRECIO CRISTAL COLORES

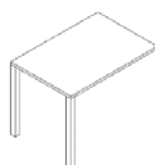

MODULO ALA RECTANGULAR

100x60	T 100A Cr▲	28	3	0,10
--------	------------	----	---	------

SOBRE CRISTAL DE SEGURIDAD MATE DE 5+5. CONSULTAR PRECIO CRISTAL COLORES

## SERIE TESEO

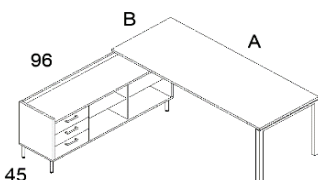
MESAS Y ALAS	A x B	REFERENCIA	P.V.P.(€)	Kg.	BUL.	M <sup>3</sup>
	Ala Derecha	200x80	<b>T•200A2D ▲</b>	100	4	0,60
		180x80	<b>T•180A2D ▲</b>	97	4	0,59
		160x80	<b>T•160A2D ▲</b>	94	4	0,58
	Ala Izquierda	200x80	<b>T•200A2I ▲</b>	100	4	0,60
		180x80	<b>T•180A2I ▲</b>	97	4	0,59
		160x80	<b>T•160A2I ▲</b>	94	4	0,58
MESA DIRECCION+ALA+CREDENZA CAJONES						
<b>PATA CERRADA: +60 €</b>						

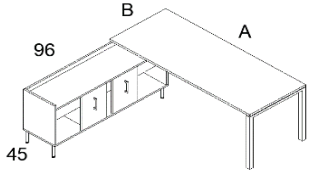
	Ala Derecha	200x80	<b>T•200A3D ▲</b>	100	4	0,60
		180x80	<b>T•180A3D ▲</b>	97	4	0,59
		160x80	<b>T•160A3D ▲</b>	94	4	0,58
	Ala Izquierda	200x80	<b>T•200A3I ▲</b>	100	4	0,60
		180x80	<b>T•180A3I ▲</b>	97	4	0,59
		160x80	<b>T•160A3I ▲</b>	94	4	0,58
MESA DIRECCION+ALA+CREDENZA PUERTAS CORRED.						
<b>PATA CERRADA: +60 €</b>						

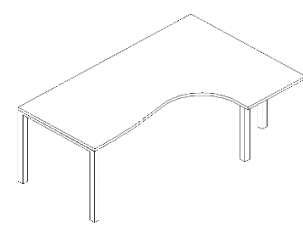
MESAS Y SEPARADORES	A x B	REFERENCIA	P.V.P.(€)	BUL.	M <sup>3</sup>	
	Derecha	200x120x80	<b>T•200FOD ▲</b>	4	0,185	
		180x120x80	<b>T•180FOD ▲</b>	4	0,170	
		160x120x80	<b>T•160FOD ▲</b>	4	0,155	
	Izquierda	200x120x80	<b>T•200FOI ▲</b>	4	0,185	
		180x120x80	<b>T•180FOI ▲</b>	4	0,170	
		160x120x80	<b>T•160FOI ▲</b>	4	0,155	
MESA COMPACTA FO						
<b>PATA CERRADA: + 120€</b>						
<b>Incluye pata cuadrada en el lado de 60 cm.</b>						

	130x30	<b>T FAG ▲</b>	1	0,09	
	<b>Para medidas de 180 y 160 cm.</b>				
	90x30	<b>T FAP ▲</b>	1	0,07	
<b>Para medidas de 140 y 120 cm.</b>					
FALDÓN METÁLICO					

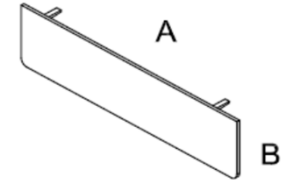
	180x40	<b>T•200FAL ▲</b>	1	0,045
	160x40	<b>T•180FAL ▲</b>	1	0,040
	140x40	<b>T•160FAL ▲</b>	1	0,035
	120x40	<b>T•140FAL ▲</b>	1	0,030
	100x40	<b>T•120FAL ▲</b>	1	0,025
FALDÓN MELAMINA				



MESAS Y SEPARADORES

A x B

REFERENCIA

P.V.P.(€)

KG.

BUL.

M<sup>3</sup>

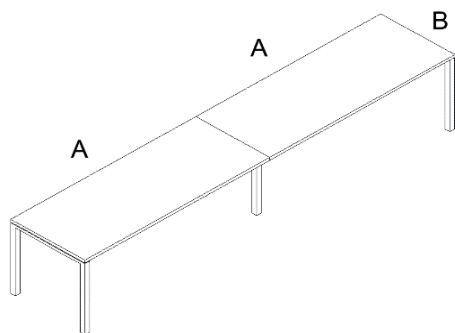

MESA DOBLE EN LÍNEA

PATA REMETIDA SOLO EN FONDO 80CM.

Mesas fondo 80cm.	
200x80	T•200L ▲
180x80	T•180L ▲
160x80	T•160L ▲
140x80	T•140L ▲
120x80	T•120L ▲
Mesas fondo 60cm.	
200x60	T•206L ▲
180x60	T•186L ▲
160x60	T•166L ▲
140x60	T•146L ▲
120x60	T•126L ▲

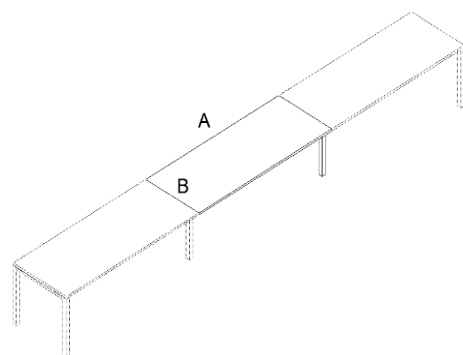

MESA PROGRESIÓN EN LÍNEA

PATA REMETIDA SOLO EN FONDO 80CM.

Mesas fondo 80cm.	
200x80	T•200PL ▲
180x80	T•180PL ▲
160x80	T•160PL ▲
140x80	T•140PL ▲
120x80	T•120PL ▲
Mesas fondo 60cm.	
200x60	T•206PL ▲
180x60	T•186PL ▲
160x60	T•166PL ▲
140x60	T•146PL ▲
120x60	T•126PL ▲

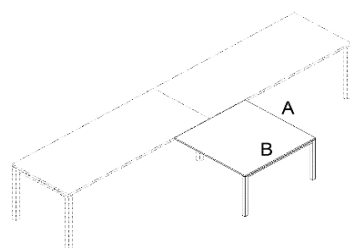

ALA DOBLE COMPARTIDA PARA DOS MESAS

100x120	T•100x120A ▲
80x120	T•80x120A ▲

# SERIE TESEO

## MESAS

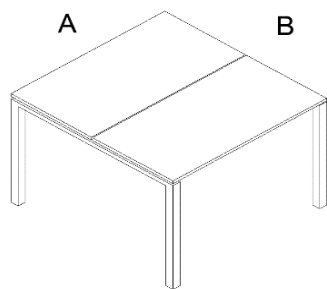

MESA BENCH

	A x B	REFERENCIA	P.V.P.(€)	KG.	BUL.	M <sup>3</sup>
Mesas fondo 80cm.	200x160	<b>T•200D ▲</b>		69	5	0,36
	180x160	<b>T•180D ▲</b>		63	5	0,34
	160x160	<b>T•160D ▲</b>		57	5	0,32
	140x160	<b>T•140D ▲</b>		51	5	0,30
	120x160	<b>T•120D ▲</b>		45	5	0,28
Mesas fondo 60 cm.	200x120	<b>T•206D ▲</b>		61	5	0,30
	180x120	<b>T•186D ▲</b>		55	5	0,28
	160x120	<b>T•166D ▲</b>		49	5	0,26
	140x120	<b>T•146D ▲</b>		43	5	0,24
	120x120	<b>T•126D ▲</b>		39	5	0,22

INDICAR SI SE QUIERE DE UNA PIEZA (POR DEFECTO EN DOS PIEZAS).

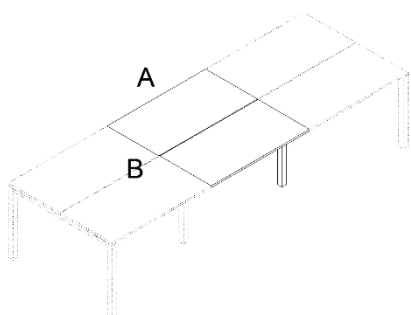

MESA PROGRESIÓN BENCH

Mesas fondo 80cm.	200x160	<b>T•200PD ▲</b>		61	5	0,36
	180x160	<b>T•180PD ▲</b>		58	5	0,34
	160x160	<b>T•160PD ▲</b>		55	5	0,32
	140x160	<b>T•140PD ▲</b>		52	5	0,30
	120x160	<b>T•120PD ▲</b>		49	5	0,28
Mesas fondo 60 cm.	200x120	<b>T•206PD ▲</b>		54	5	0,30
	180x120	<b>T•186PD ▲</b>		51	5	0,28
	160x120	<b>T•166PD ▲</b>		48	5	0,26
	140x120	<b>T•146PD ▲</b>		45	5	0,24
	120x120	<b>T•126PD ▲</b>		43	5	0,22

INDICAR SI SE QUIERE DE UNA PIEZA (POR DEFECTO EN DOS PIEZAS).

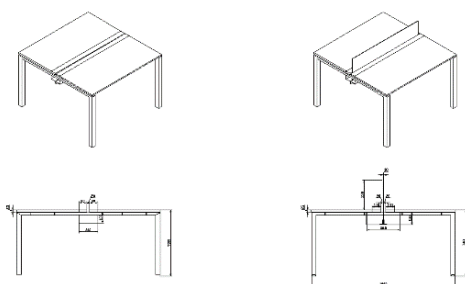

CANALETA ELECTRIFICACION CENTRAL

+ DOBLE TAPETA ABATIBLE

SIN Separador	200x10	<b>T ELE200 ▲</b>		14	1	0,090
	180x10	<b>T ELE180 ▲</b>		12	1	0,080
	160x10	<b>T ELE160 ▲</b>		10	1	0,070
	140x10	<b>T ELE140 ▲</b>		8	1	0,060
	120x10	<b>T ELE120 ▲</b>		6	1	0,05
CON Separador	200x10	<b>T•ELESEP200 ▲</b>		19	2	0,13
	180x10	<b>T•ELESEP180 ▲</b>		17	2	0,12
	160x10	<b>T•ELESEP160 ▲</b>		15	2	0,11
	140x10	<b>T•ELESEP140 ▲</b>		12	2	0,095
	120x10	<b>T•ELESEP120 ▲</b>		9	2	0,085

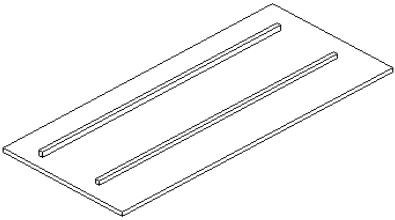
MESAS	A x B	REFERENCIA	P.V.P.(€)	KG.	BUL.	M <sup>3</sup>
 <p>ENCIMERAS INCLUYEN DOS VIGAS METÁLICAS</p>	FONDO 80 cm.	200x80	<b>T•TA200 ▲</b>	26	2	0,090
		180x80	<b>T•TA180 ▲</b>	23	2	0,080
		160x80	<b>T•TA160 ▲</b>	20	2	0,070
		140x80	<b>T•TA140 ▲</b>	17	2	0,060
		120x80	<b>T•TA120 ▲</b>	14	2	0,050
		FONDO 60 cm.	200x60	<b>T•TA206 ▲</b>	23	2
	180x60		<b>T•TA186 ▲</b>	20	2	0,070
	160x60		<b>T•TA166 ▲</b>	17	2	0,060
	140x60		<b>T•TA146 ▲</b>	14	2	0,050
	120x60		<b>T•TA126 ▲</b>	12	2	0,040

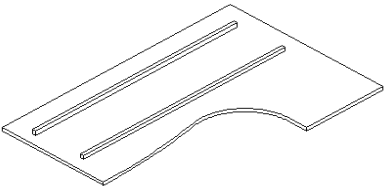
 <p>ENCIMERAS FO INCLUYEN DOS VIGAS METÁLICAS</p>	Derecha	200x120x80	<b>T•TA200FOD ▲</b>	30	2	0,103
		180x120x80	<b>T•TA180FOD ▲</b>	27	2	0,090
		160x120x80	<b>T•TA160FOD ▲</b>	24	2	0,080
	Izquierda	200x120x80	<b>T•TA200FOI ▲</b>	30	2	0,103
		180x120x80	<b>T•TA180FOI ▲</b>	27	2	0,090
		160x120x80	<b>T•TA160FOI ▲</b>	24	2	0,080

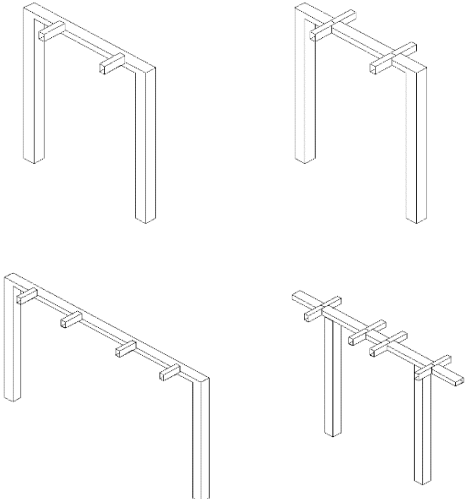
PATAS	A x B	REFERENCIA	P.V.P.(€)	KG.	BUL.	M <sup>3</sup>
	Ancho 60	60x71	<b>T PS 60 ▲ (TERMINAL)</b>	6,5	1	0,070
		60x71	<b>T PI 60 ▲ (INTERMEDIA)</b>	7	1	0,070
	Ancho 80	80x71	<b>T PS 80 ▲ (TERMINAL)</b>	7	1	0,090
		80x71	<b>T PI 80 ▲ (INTERMEDIA)</b>	7,5	1	0,090
	Ancho 120	120x71	<b>T PS 120 ▲ (TERMINAL)</b>	7,5	1	0,140
		100x71	<b>T PI 120 ▲ (INTERMEDIA)</b>	7,5	1	0,140
	Ancho 160	160x71	<b>T PS 160 ▲ (TERMINAL)</b>	8,5	1	0,180
		140x71	<b>T PI 160 ▲ (INTERMEDIA)</b>	8,5	1	0,180

PATAS

	71x5	<b>T P FO ▲</b>	3	1	0,002
---	------	-----------------	---	---	-------

PATA CUADRADA PARA MESA FO

## SERIE TESEO

### MESAS DE JUNTAS

A x B

REFERENCIA

P.V.P.(€)

KG. BUL. M<sup>3</sup>

MELAMINA FENÓLICO ESTRATIFICADO  
BLANCO 13 MM. BLANCO

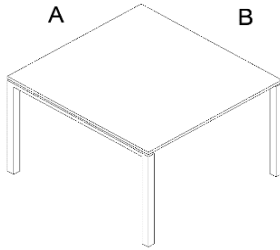

Melamina	120x120	<b>T•J120▲</b>			37	4	0,22
----------	---------	----------------	--	--	----	---	------

Cristal	120x120	<b>T Cr J120▲</b>			57	4	0,22
---------	---------	-------------------	--	--	----	---	------

SOBRE CRISTAL DE SEGURIDAD MATE 5+5. CONSULTAR PRECIO CRISTAL COLORES

DISPONIBLE EN FONDO 100 CM. AL MISMO PRECIO

### MESA DE JUNTAS CUADRADA

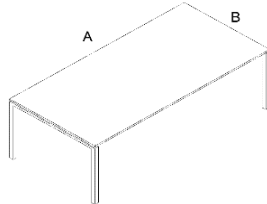

MELAMINA FENÓLICO ESTRATIFICADO  
BLANCO 13 MM. BLANCO

Melamina	200x120	<b>T•J200▲</b>			45	4	0,30
----------	---------	----------------	--	--	----	---	------

Melamina	240x120	<b>T•J240▲</b>			49	4	0,34
----------	---------	----------------	--	--	----	---	------

DISPONIBLE EN FONDO 100 CM. AL MISMO PRECIO

### MESA DE JUNTAS RECTANGULAR



Melamina	110 Ø	<b>T•J110Ø P▲</b>			43	3	0,07
----------	-------	-------------------	--	--	----	---	------

Melamina	120 Ø	<b>T•J120Ø P▲</b>			47	3	0,08
----------	-------	-------------------	--	--	----	---	------

Melamina	130 Ø	<b>T•J130Ø P▲</b>			50	3	0,09
----------	-------	-------------------	--	--	----	---	------

Cristal	110 Ø	<b>T Cr J110Ø P▲</b>			120	3	0,07
---------	-------	----------------------	--	--	-----	---	------

Cristal	120 Ø	<b>T Cr J120Ø P▲</b>			145	3	0,08
---------	-------	----------------------	--	--	-----	---	------

Cristal	130 Ø	<b>T Cr J130Ø P▲</b>			169	3	0,09
---------	-------	----------------------	--	--	-----	---	------

SOBRE CRISTAL DE SEGURIDAD MATE 5+5. CONSULTAR PRECIO CRISTAL COLORES

### MESA JUNTAS CIRCULAR (PATAS INCLUIDAS)

### ACCESORIOS

A x B

REFERENCIA

P.V.P.(€)

KG. BUL. M<sup>3</sup>

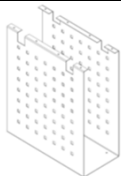

	20x45x40	<b>O SOP CPU▲</b>			6	1	0,100
--	----------	-------------------	--	--	---	---	-------

### SOPORTE CPU COLGADO

VER OPCIONES DE ELECTRIFICACIÓN EN PAGINAS 260 Y SIGUIENTES

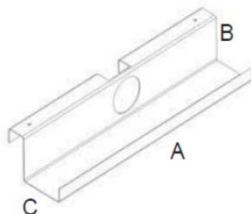

	90x10x12	<b>T ELE PEQ▲</b>			1	1	0,006
--	----------	-------------------	--	--	---	---	-------

Para mesas de 120 y 140 cm.

	130x10x12	<b>T ELE GRA▲</b>			2	1	0,008
--	-----------	-------------------	--	--	---	---	-------

Para mesas de 160 y 180 cm.

### CANALETA ELECTRIFICACIÓN



	107x91,5	<b>T • GOTA▲</b>			19	2	0,065
--	----------	------------------	--	--	----	---	-------

### MESA GOTA DE EXTENSIÓN

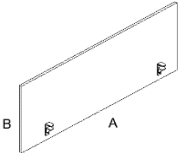
PANELES SEPARADOR MESA	A x B	REFERENCIA	P.V.P.(€)	KG.	BUL.	M <sup>3</sup>
 <p>PANEL SEPARADOR MESA MELAMINA 19 MM. VUELO 30 CM.</p>	190x40	<b>T•S200</b>		11	1	0,045
	170x40	<b>T•S180</b>		10	1	0,040
	150x40	<b>T•S160</b>		9	1	0,035
	130x40	<b>T•S140</b>		8	1	0,030
	110x40	<b>T•S120</b>		7	1	0,025

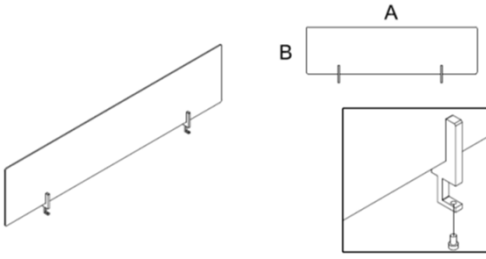
 <p>PANEL SEPARADOR MESA METACRILATO 6 MM. VUELO 38 CM.</p>	190x38	<b>Y SEPCR200</b>		10	1	0,045
	170x38	<b>Y SEPCR180</b>		9,5	1	0,040
	150x38	<b>Y SEPCR160</b>		9	1	0,035
	130x38	<b>Y SEPCR140</b>		8,5	1	0,030
	110x38	<b>Y SEPCR120</b>		8	1	0,025
	90x38	<b>Y SEPCR100</b>		7,5	1	0,020
	70x38	<b>Y SEPCR80</b>		7	1	0,015

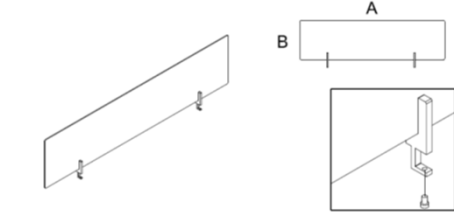
 <p>PANEL SEPARADOR MESA. MELAMINA 10 MM. TAPIZADO GRUPO 1 - VUELO 38 CM.</p>	190x38	<b>Y SEPT200</b>		5,8	1	0,045
	170x38	<b>Y SEPT180</b>		5,5	1	0,040
	150x38	<b>Y SEPT160</b>		5,2	1	0,035
	130x38	<b>Y SEPT140</b>		4,9	1	0,030
	110x38	<b>Y SEPT120</b>		4,6	1	0,025
	90x38	<b>Y SEPT100</b>		4,3	1	0,020
	70x38	<b>Y SEPT80</b>		4	1	0,015

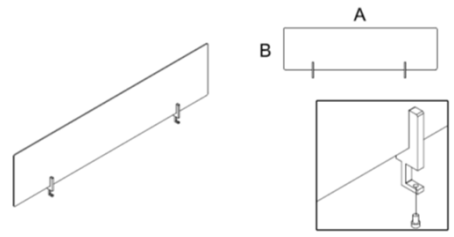
 <p>PANEL SEPARADOR MESA FONOAORSORBENTE 39 MM. TAPIZADO GRUPO 1 - VUELO 38 CM.</p>	190x38	<b>G SEPF200</b>		10	1	0,045
	170x38	<b>G SEPF180</b>		9,5	1	0,040
	150x38	<b>G SEPF160</b>		9	1	0,035
	130x38	<b>G SEPF140</b>		8,5	1	0,030
	110x38	<b>G SEPF120</b>		8	1	0,025
	90x38	<b>G SEPF100</b>		7,5	1	0,020
	70x38	<b>G SEPF80</b>		7	1	0,015

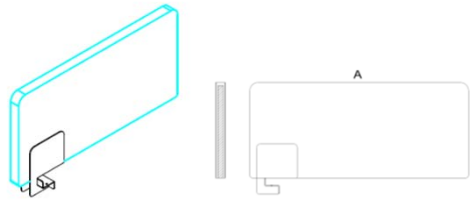
PANELES SEPARADOR MESA	A x B	REFERENCIA	P.V.P.(€)	KG.	BUL.	M <sup>3</sup>
 <p>PANEL SEPARADOR LATERAL MESA FONOAORSORBENTE 39 MM. TAPIZADO GRUPO 1 - VUELO 38 CM.</p>	80x35	<b>G SEPLATF80</b>			1	
	70x35	<b>G SEPLATF70</b>			1	
	60x35	<b>G SEPLATF60</b>			1	

## SERIE TESEO

PANELES SEPARADORES SOBRE MESA PARA BENCH DE 1 PIEZA DE FONDO 160 Ó 120 CM.

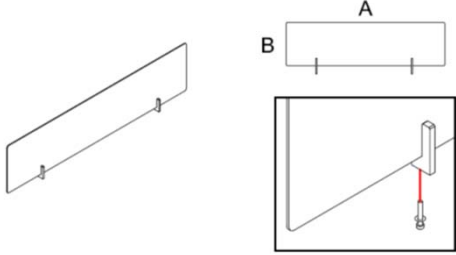
		A x B	REFERENCIA	P.V.P.(€)	Kg.	BUL.	M <sup>3</sup>
	190x38	<b>Y•SM200</b>	5,5	1	0,045		
	170x38	<b>Y•SM180</b>	5,2	1	0,040		
	150x38	<b>Y•SM160</b>	4,9	1	0,035		
	130x38	<b>Y•SM140</b>	4,6	1	0,030		
	110x38	<b>Y•SM120</b>	4,3	1	0,025		
	90x38	<b>Y•SM100</b>	4	1	0,020		
	PANEL SEPARADOR MESA MELAMINA 19 MM. - VUELO 38 CM.	70x38	<b>Y•SM80</b>	3,7	1	0,015	

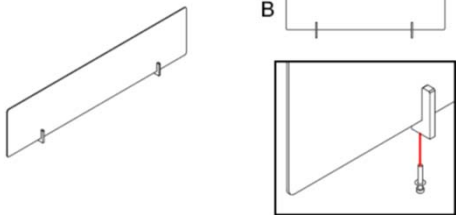
	190x38	<b>Y SCR200</b>	10	1	0,045
	170x38	<b>Y SCR180</b>	9,5	1	0,040
	150x38	<b>Y SCR160</b>	9	1	0,035
	130x38	<b>Y SCR140</b>	8,5	1	0,030
	110x38	<b>Y SCR120</b>	8	1	0,025
	90x38	<b>Y SCR100</b>	7,5	1	0,020
	PANEL SEPARADOR MESA METACRILATO 6 MM. - VUELO 38 CM.	70x38	<b>Y SCR80</b>	7	1

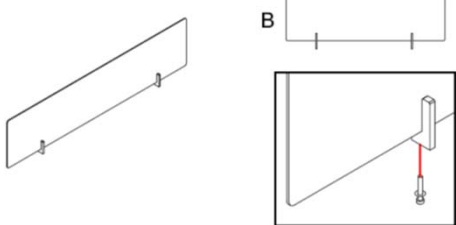
	190x38	<b>Y ST200</b>	5,8	1	0,045
	170x38	<b>Y ST180</b>	5,5	1	0,040
	150x38	<b>Y ST160</b>	5,2	1	0,035
	130x38	<b>Y ST140</b>	4,9	1	0,030
	110x38	<b>Y ST120</b>	4,6	1	0,025
	90x38	<b>Y ST100</b>	4,3	1	0,020
	PANEL SEPARADOR MESA. MELAMINA 10 MM. TAPIZADO GRUPO 1 - VUELO 38 CM.	70x38	<b>Y ST80</b>	4	1

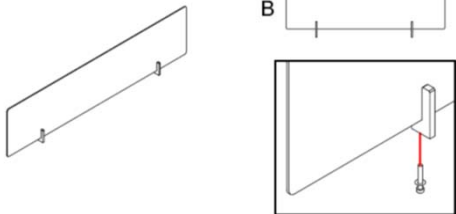
	190x38	<b>G SF200</b>	10	1	0,045
	170x38	<b>G SF180</b>	9,5	1	0,040
	150x38	<b>G SF160</b>	9	1	0,035
	130x38	<b>G SF140</b>	8,5	1	0,030
	110x38	<b>G SF120</b>	8	1	0,025
	90x38	<b>G SF100</b>	7,5	1	0,020
	PANEL SEPARADOR MESA FONOAORSORBENTE 39 MM. TAPIZADO GRUPO 1 - VUELO 38 CM.	70x38	<b>G SF80</b>	7	1

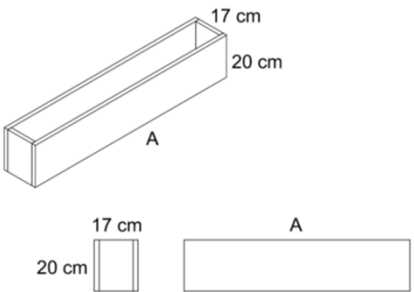
JARDINERA SOBRE MESA/ARMARIO	A	REFERENCIA	P.V.P.(€)	Kg.	BUL.	M <sup>3</sup>
	190	<b>G•JAR200</b>		1		
	170	<b>G•JAR180</b>		1		
	150	<b>G•JAR160</b>		1		
	130	<b>G•JAR140</b>		1		
	110	<b>G•JAR120</b>		1		
	90	<b>G•JAR100</b>		1		
	JARDINERA MELAMINA PARA COLOCAR SOBRE MESA O SOBRE ARMARIO (CINTA DOBLE CARA EN EL FONDO)	70	<b>G•JAR80</b>		1	