

For MDF Italia, design is about shaping matter with ideas. More than simple products, the results of this process are thought forms. Our vocation has always been to create objects that not only become icons but will also succeed in defining the canon of contemporary design.

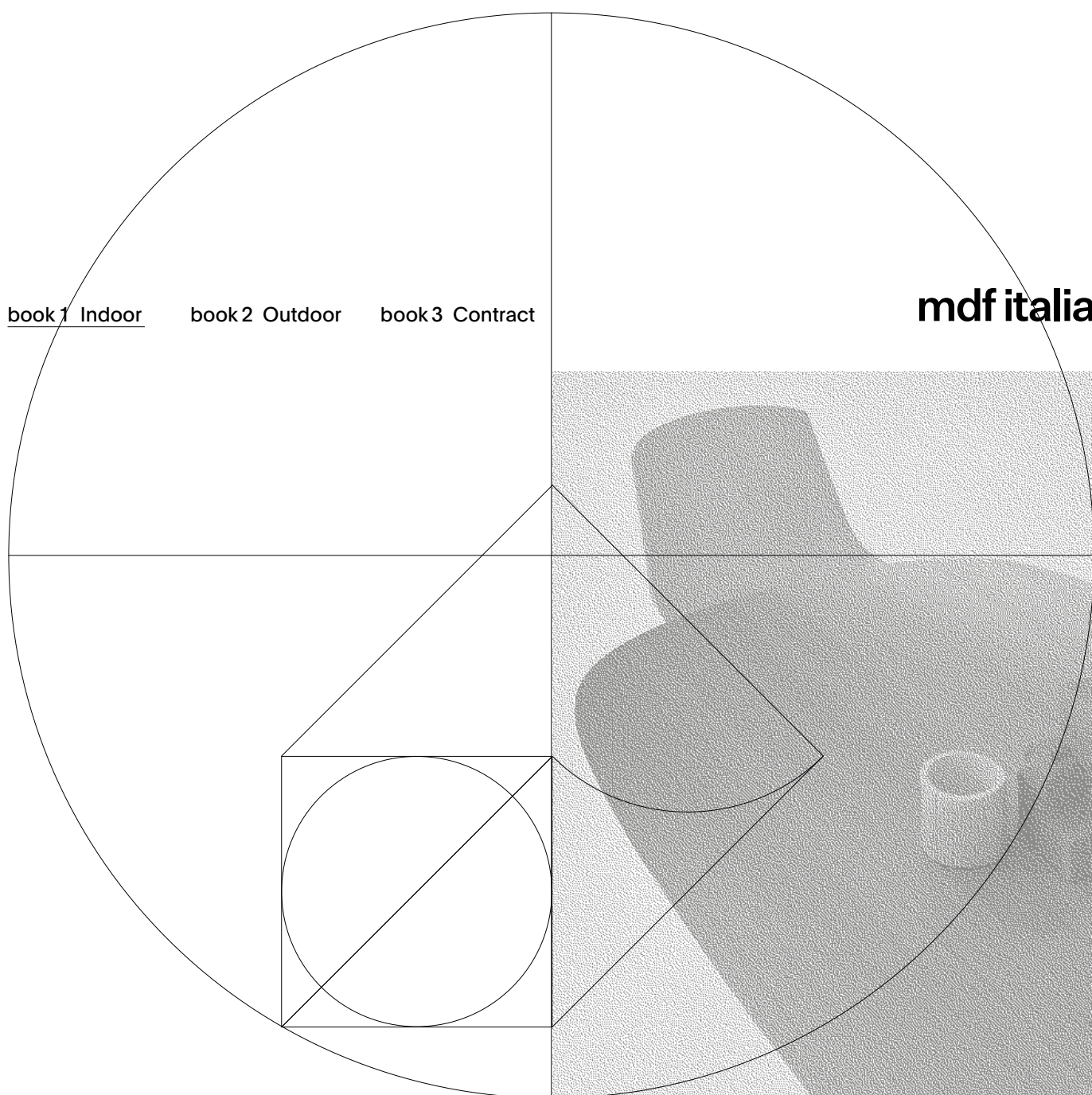

Indoor book

Communita®

Indoor Index	Sofas and armchairs	Tables and desks	Stools and poufs
Introduction	2 Cosy collection	34 Axy	128 Aïku Stool
Indoor collection	4 Mate	50 Extension	132 Flow Pouf
Company profile	9 Mia	54 La Grande Table	134 Flow Stool
	Neil	60 Lim 3.0	138 Fuji pouf
30 years	Neil Twist armchair	62 NVL Table	144 Neil Stool
Capsule collection	387 Yale collection	66 Offset	154 Sag
		Rock Table collection	164
	Bookcases	S Table	176 Beds
		Tense collection	182
	Melody	74 Tense Curve	198 Aluminium Bed
	Random collection	76 20. Venti system	200 Yale Bed
	Randomissimo	86 20. Venti Home	206
	Randomito	88	
		Coffee Tables	Complements
	Systems		Divide IT
		Arpa Low Table	212 Frammenti
	Minima collection	92 Cosy Low Table	214 Tatami
	Pentagramma	118 Flow Low Table	216 Le Banc
		Fossil	220 Link 1
		La Table Basse	224 Mamba collection
		Metodo	226 Mirror Lines
		Rock Table Mini	228 Office Cabinets
		Tense Low Table	232 Ombre
		Yale Low Table	236
		Chairs	
		Achille collection	242
		Aïku collection	250
		Flow collection	256
		Flow Filo	280
		M1	284
		Neil collection	288
		Neil Denim	302
		Universal collection	306

Indoor book

mdf italia



Click here

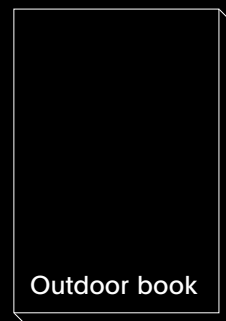

Outdoor book



Click here

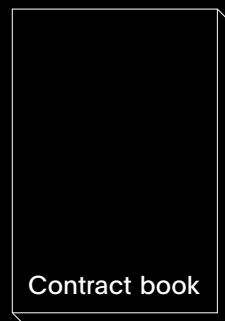

Contract book

^{EN} Every place has a soul, which demands to be caught, interpreted, enhanced. This is the mission of our indoor furniture, objects designed to fit harmoniously into any domestic space, amplifying its character and functionality. Characterised by design mastery, versatility of use and quality of manufacture and materials, they are more than simple products, but tangible manifestations of our way of thinking and relating to the world.

^{IT} Ogni luogo ha un'anima, che chiede di essere colta, interpretata, valorizzata. Questa è la missione dei nostri arredi indoor, oggetti concepiti per inserirsi armoniosamente in qualsiasi spazio domestico, amplificandone il carattere e la funzionalità. Caratterizzati da maestria progettuale, versatilità d'uso e qualità della realizzazione e dei materiali, per noi non sono semplici prodotti, ma manifestazioni tangibili del nostro modo di pensare e relazionarci con il mondo.

Sofas and armchairs

p. 33



Cosy



Mate



Neil



Yale X sofa



Cosy Curve



Mia sofa



Yale sofa



Yale X armchair



Cosy Island



Mia armchair



Yale armchair



Neil Twist armchair

Bookcases

p. 73



Melody



Randomito



Random collection



Randomissimo

Systems

p. 91

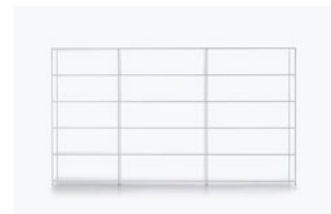

Minima collection



Pentagramma

Tables and desks

p. 127



Axy



Lim 3.0



Rock Table collection



Tense Curve



Extension



NVL Table



S Table



20. Venti system



La Grande Table



Offset



Tense collection



20. Venti Home

Coffee Tables

p. 211



Arpa Low Table



Fossil



Rock Table Mini



Cosy Low Table



La Table Basse



Tense Low Table



Flow Low Table



Metodo



Yale Low Table

MDF Italia Indoor products

Chairs

p. 241



Achille collection



Flow Filo



Universal collection



Aïku collection



M1



Flow collection



Neil collection

Stools and poufs

p. 325



Aïku Stool



Fuji pouf



Flow Pouf



Neil Stool



Flow Stool



Sag

Beds

p. 347



Aluminium Bed



Yale Bed

Complements

p. 359



Divide IT



Le Banc

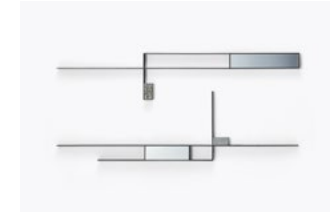

Mirror Lines

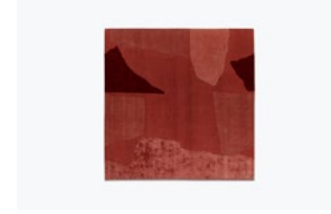

Frammenti

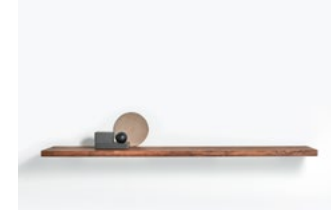

Link 1



Office Cabinets



Tatami



Mamba collection



Ombre

30 years Capsule collection

p. 387



Le Banc



Minima



Lofty



Tense

Thought

For MDF Italia, design is about shaping matter with ideas. More than simple products, the results of this process are thought forms.

Per MDF Italia, progettare significa plasmare la materia con le idee. Il risultato di questo processo non sono semplici prodotti, ma forme del pensiero.

forms.

Our vocation has always been to create objects that not only become icons but will also succeed in defining the canon of contemporary design.

Da sempre, la nostra vocazione è creare oggetti che non solo abbiano la capacità di diventare icone, ma riescano nell'impresa di stabilire un canone del design contemporaneo.

We believe that design must reflect the surrounding context and the complexities of today's world. From the outset in 1992, together with our designers and craftspeople, we have placed this idea at the forefront of our work.

A number of distinctive features have made us both unique and identifiable: formal simplicity, volumetric lightness, long-lasting design and innovative use of materials.

We have taken up the challenge of bringing together contrasting forces: minimalism and emotion, synthesis and narrative, function and wonder. We are pioneers in finding new ways of envisaging space.

Crediamo che il design debba riflettere il contesto che ci circonda e le nuove complessità del mondo. Dal 1992 l'abbiamo messo al centro del nostro lavoro, insieme a progettisti e maestranze che pensano e realizzano prodotti dall'identità evoluta.

Dalla nostra parte, abbiamo una serie di tratti distintivi che ci hanno resi unici e riconoscibili: semplicità formale, leggerezza dei volumi, longevità dei segni e innovazione dei materiali.

Sfidiamo l'esistente con l'obiettivo di far convivere spinte contrapposte: fra minimalismo ed emozione, sintesi e racconto, funzionalità e meraviglia, siamo pionieri di nuovi modi di concepire lo spazio.



Discover the Company Profile



Watch the Corporate Video

Vision

We safeguard and value the intrinsic quality of every space through design.

Proteggiamo e valorizziamo le qualità proprie di ogni spazio attraverso il design.

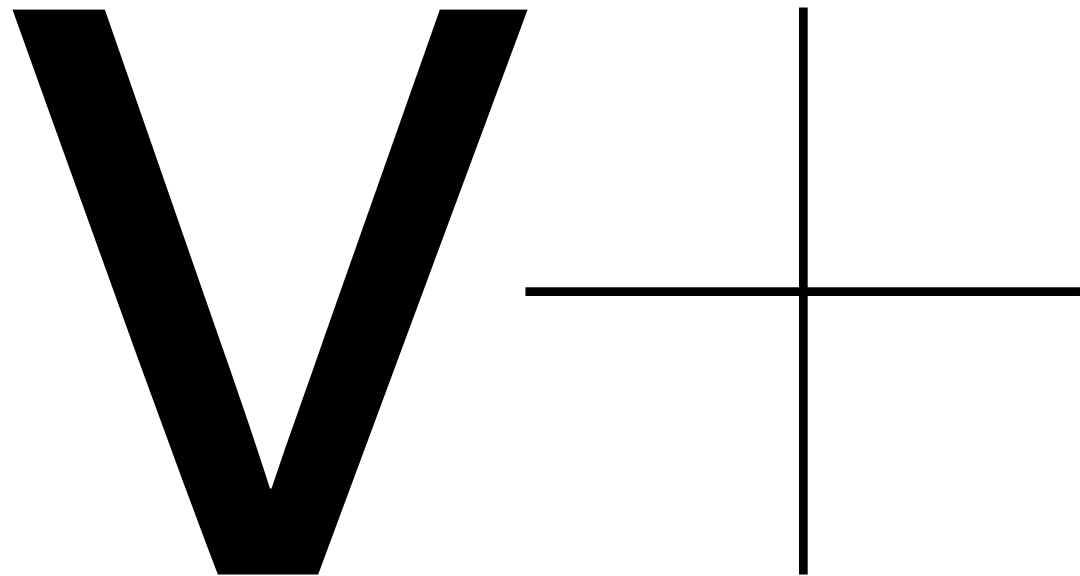

Mission

We create and produce designer items and furnishings in the pursuit of excellence. They embody a quest for the essential and ensure that each space — domestic, work or hospitality — becomes unique.

Pensiamo e produciamo arredi e oggetti di design che aspirano all'eccellenza, caratterizzati dalla sfida progettuale e dall'essenzialità delle forme, pensati per rendere unico ogni luogo domestico, di lavoro o dedicato all'ospitalità.

/Simplicity
 /Challenge
 /Lightness
 /Rhythm
 /Wonder
 /Time

Simplicity

Our philosophy is inspired by simplicity. Everything we do is the fruit of a dialectic eliminating all traces of the superfluous in order to encapsulate, in a single gesture, the maximum meaning.

Challenge

Every decision we take is dictated by the desire to push ourselves to the limit and beyond what is considered possible, to challenge the standards of the market and society as a whole. This approach gives rise to ideas, products and solutions that cannot be easily categorised and stimulate debate in contemporary design.

Lightness

Synthesis is part of our design method, a work of continuous subtraction: of materials, elements, thought. The resulting creations are characterised by lightness of form and compositional harmony.

Rhythm

We believe in the necessity of evolving in a harmonious and controlled way. This is reflected in a dynamic sign, which tends towards a compositional balance and the creation of aesthetic and design canons destined to be replicated over time.

Wonder

Design must not limit itself to decoration or problem solving, but rather produce a reaction of wonder in the beholder. That's why we conceive and realise products that exceed expectations and amaze our clients.

Time

We aspire to interpret the past, live the present and anticipate the future. To this end we combine undying ideas and create timeless products, fashioned in such a way as to last and be enjoyed, once passed on, another life.

Semplicità

La nostra filosofia è ispirata alla semplicità. Tutto ciò che facciamo è frutto di un'operazione dialettica che elimina la moltitudine di azioni superflue per condensare in un solo gesto il massimo del significato.

Sfida

Ogni decisione che prendiamo è dettata dalla volontà di spingerci oltre i limiti di ciò che è considerato possibile, sfidando gli standard del mercato e della società. Questo approccio dà vita a pensieri, prodotti e soluzioni non omologate, che stimolano il dibattito sul design contemporaneo.

Leggerezza

Utilizziamo la sintesi come metodologia progettuale, in un'operazione continua di sottrazione della materia, degli elementi, del pensiero. Il risultato sono oggetti caratterizzati dalla leggerezza delle forme e dall'equilibrio compositivo.

Ritmo

Crediamo nella necessità di evolvere in modo armonico e controllato. Questo si riflette in un segno dinamico, che tende all'equilibrio compositivo e alla creazione di canoni estetici e progettuali destinati a replicarsi nel tempo.

Meraviglia

Il design non deve limitarsi alla decorazione o alla risoluzione di problemi, deve provocare un senso di stupore in chi ne è testimone. Per questo concepiamo e realizziamo prodotti che superano le aspettative e ispirano un senso di meraviglia nelle persone.

Tempo

Aspiriamo a interpretare il passato, vivere il presente e anticipare il futuro. Per questo sposiamo idee immortali e realizziamo prodotti senza tempo, progettati per durare a lungo e poter godere, una volta dismessi, di un'altra vita.

The story of MDF Italia begins in 1992, when Bruno Fattorini, first economist, then designer and art director, founded the company based on his profound knowledge of culture and aesthetics, rapidly transforming it into one of the most interesting and innovative design companies in Italy.

La storia di MDF Italia inizia nel 1992. Il fondatore Bruno Fattorini, studioso di economia, poi designer e art director, basa l'azienda su una approfondita riflessione culturale ed estetica, trasformandola in breve tempo in una delle realtà più interessanti e innovative del design italiano.

mdf italia,



since 1992

Back in the early 1990s minimalism, from a niche movement, began to inspire a certain kind of creativity and thought. MDF Italia interpreted this in its own way, more as addition rather than subtraction, in a research work that expressed a radically new way of doing things. Aluminium, hitherto a material used for workspaces, entered the domestic sphere; the products were essential but their apparent simplicity concealed an avant-garde technology and a profound thought process. Before long recognition and awards arrived, with pieces such as the Minima and Random bookcases, the Le Banc bench and the Tense table becoming new design icons.

Siamo all'inizio degli anni Novanta: il minimalismo, da movimento di nicchia, inizia a ispirare un certo tipo di creatività e di pensiero. MDF Italia lo reinterpreta a suo modo, più come addizione che come sottrazione, in una ricerca che esprime il nuovo in modo radicale. L'alluminio, da materiale tecnico destinato agli spazi di lavoro, entra nell'ambiente domestico; i prodotti sono essenziali, ma la loro apparente semplicità cela una tecnologia all'avanguardia e un pensiero profondo. Premi e riconoscimenti non tardano ad arrivare, mentre alcuni pezzi – come le librerie Minima e Random, la panca Le Banc e il tavolo Tense – diventano le nuove icone del design.

- | | | |
|--|---|--|
| <p>1992
Bruno Fattorini sets up MDF Italia.</p> <p>1995
The LIM collection introduces the use of aluminium, a material from the industrial world, into the home.</p> <p>1998
Fattorini designs Minima, a bookcase system composed of three basic elements: shelves, up-rights and storage.</p> <p>2001
Xavier Lust designs Le Banc, a bench made of curved aluminium, only 6 mm thick. It is MDF Italia's first collaboration with a foreign designer.</p> | <p>2004
Presentation of Lofty, a stainless steel set of chairs, by Piergiorgio Cazzaniga.</p> <p>2005
Neuland Industriedesign and MDF Italia present Random, transforming the traditional bookcase from a functional storage unit to a design sculpture.</p> <p>2007
The Cassina family acquires the MDF Italia trademark.</p> <p>2009
Piergiorgio and Michele Cazzaniga design the Tense table, an icon of lightness and flexibility, which, thanks to its internal structure, can be extended up to 4 metres in length.</p> | <p>2011
The Yale sofa by Jean-Marie Massaud is awarded the Compasso d'Oro (Golden Compass).</p> <p>2016
MDF Italia tasks Studio Bestetti with the renovation of their headquarters in Mariano Comense.</p> <p>2019
With the acquisition of the historic brand Acerbis, MDF Italia becomes a group.</p> <p>2022
MDF Italia presents the Principle of Lightness collection to mark the company's 30th anniversary.</p> |
|--|---|--|

Thirty years of MDF Italia design.

The occasion of the group's 30th anniversary MDF Italia launched the Capsule Collection, Principle of Lightness: a limited edition of four iconic products from the MDF Italia collection, frozen in time yet ready for a new life.

In occasione del suo 30° anniversario, MDF Italia realizza la capsule collection The Principle of Lightness: quattro prodotti eccellenti della storia di MDF Italia in edizione limitata, congelati nel tempo e insieme pronti per una nuova vita.

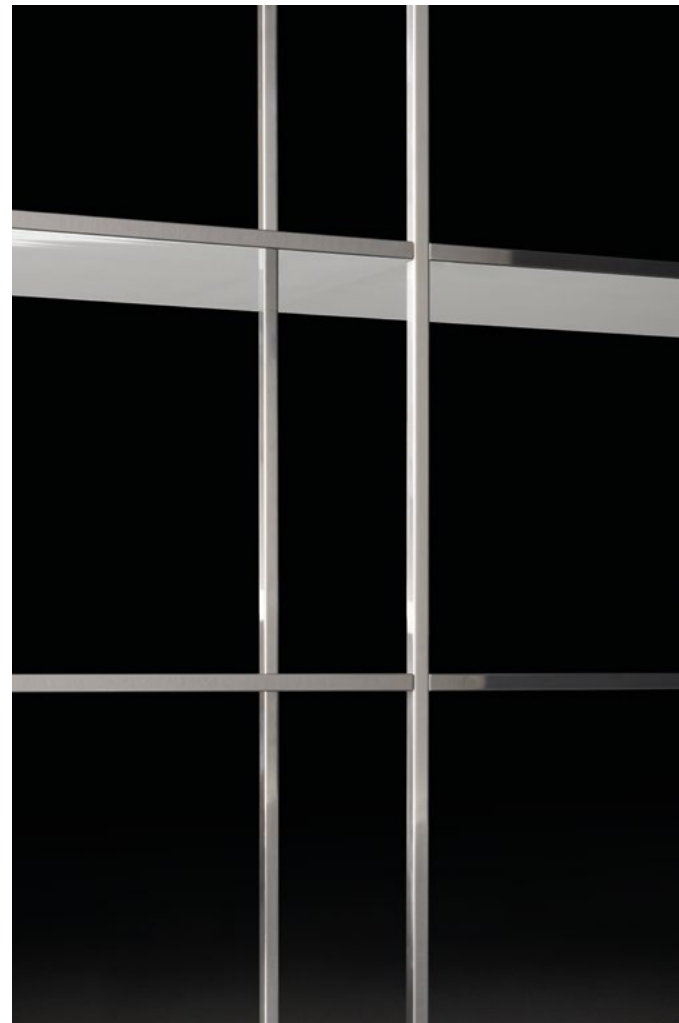
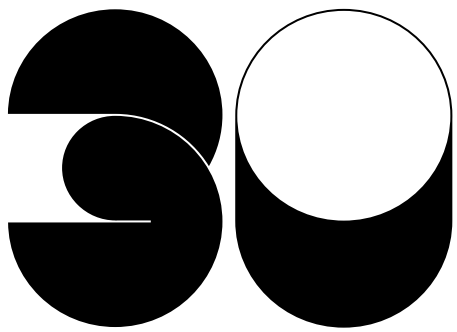



The Brianza region is the historic heart of Italy's design industry, the cradle of know-how and skill Made-in-Italy, while the city of Milan, synonymous with avant garde, vision and innovation, has attracted talent and finance like no other. MDF Italia is a Milanese design company with headquarters in Brianza.

Nella geografia del design italiano, la Brianza è il cuore storico, culla del saper fare e dell'ingegno made in Italy, mentre Milano è avanguardia, visione, innovazione, il luogo che più di ogni altro è stato capace di attrarre intelligenze e investimenti. MDF Italia è un'azienda milanese di design, con sede in Brianza.

HQ

The project guidelines for the Mariano Comense base are the same as those for our products: simplicity, lightness and innovation. The architecture, designed by Studio Bestetti is calm and discreet. It provides a fluid home for work, human relationships and exhibitions. The glass panels enable a dialogue between the inside and the outside, with the surrounding nature becoming part of the interior. Bearing witness to our aesthetic manifesto, the building provides a synthesis of our values as well as of our ambitions for the future. The showroom, remodelled in 2020 by the studio of Israeli architect Pitsou Kedem, is both dynamic and inviting, as a result of the interaction between solid volumes and soft filters guiding the visitor along a visual and sensory passage.

Le linee progettuali della sede di Mariano Comense sono le stesse che caratterizzano i nostri prodotti: semplicità, leggerezza e innovazione. L'architettura, progettata dallo Studio Bestetti, è silenziosa e discreta, e ospita in modo fluido spazi di lavoro, di relazione ed espositivi. Le vetrate mettono in dialogo interni ed esterni facendo irrompere nello spazio la natura circostante. Manifesto della nostra estetica, la sede è una sintesi dei nostri valori e delle nostre ambizioni. Lo showroom, rinnovato nel 2020 dallo studio di architettura israeliano Pitsou Kedem, è un luogo dinamico e avvolgente, esito dell'interazione tra volumi solidi e filtri morbidi che guidano il visitatore attraverso un percorso visivo e sensoriale.

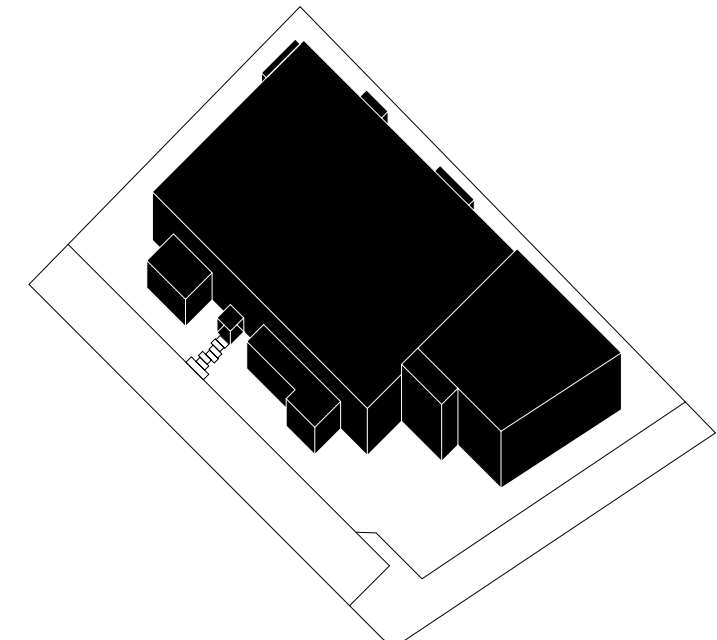

The lightness of design.

Point, line and surface. The common denominator of all MDF Italia's products is lightness, concise forms that reflect the rigorous precision of the design. There are no casual elements in this work of subtraction: the superfluous is eliminated to reveal the meaning and soul of the objects. A lightness that is embodied, time and again, in the absolute simplicity of a table composed of four vertical legs and a horizontal surface, in the essential and unadorned contours of a chair, in the radicalism of a bookcase that revolutionises the idea of storage. In a style that remains recognisable in time and over time.

Punto, linea, superficie. La caratteristica comune a tutti i prodotti di MDF Italia è la leggerezza, una concisione di forme che si nutre dell'estrema precisione di progettazione. Nessun tratto è casuale in questo lavoro di sottrazione mai fine a se stesso, che porta dritto al senso e all'anima delle cose. Una leggerezza che di volta in volta si incarna nella semplicità assoluta di un tavolo composto di quattro gambe verticali e una superficie orizzontale, nell'essenzialità di una seduta fatta solo delle sue linee di contorno, nel radicalismo di una libreria che rivoluziona il concetto di contenimento. In uno stile che rimane riconoscibile nel tempo e oltre il tempo.

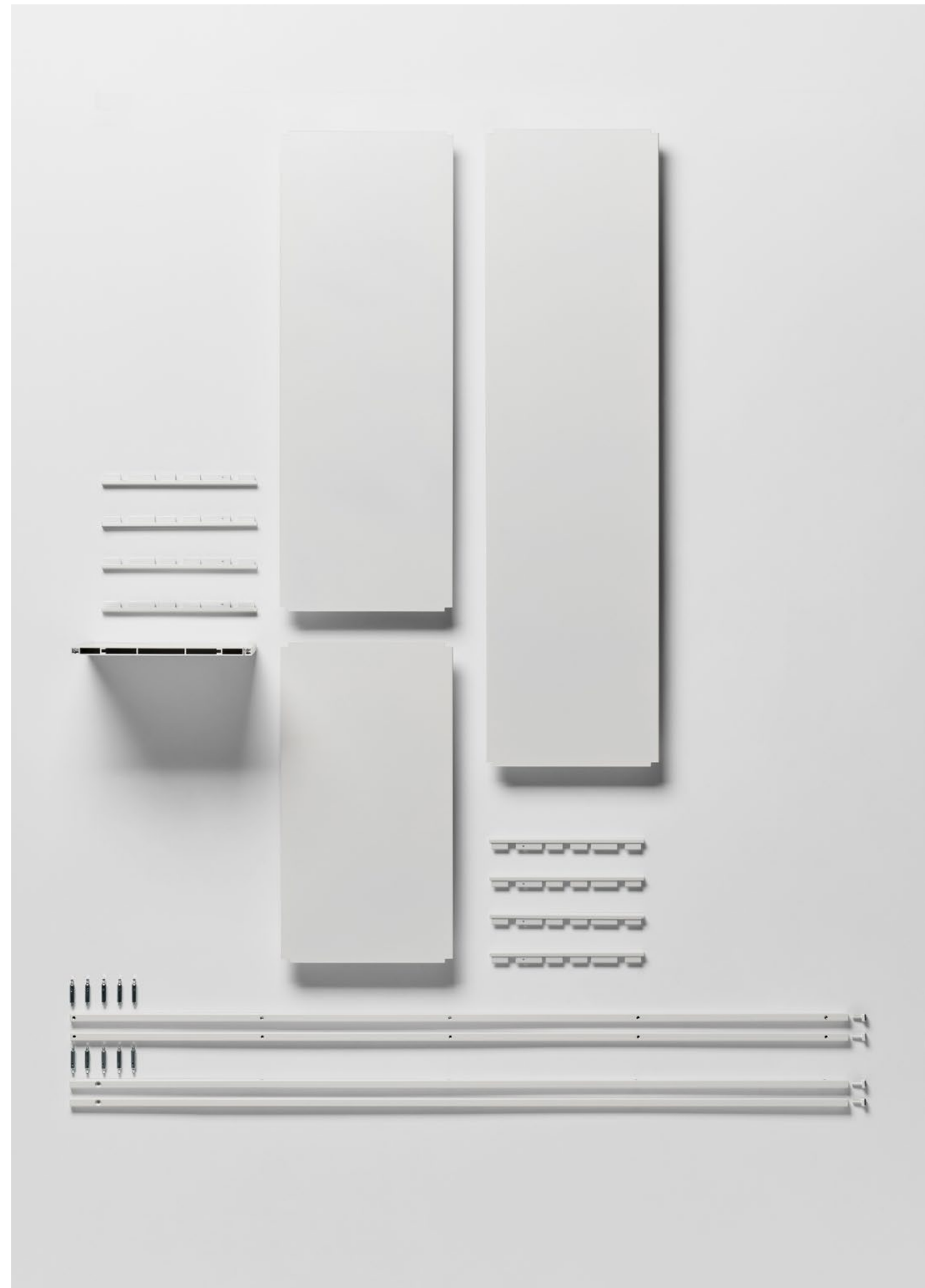



Project culture.

MDF Italia's aesthetic lies, above all, in its design methodology. In our work we seek to unveil the soul of the project, to render its substance tangible and visible. Technological and material innovation have been distinctive features, terrain of experimentation since the start. We were among the first to use Cristalplant, a lightweight cement (UHPFRC) previously used only in architecture, cement and marble on tabletops. We operate both with industrial and artisan processes depending on the final result we wish to obtain.

L'estetica di MDF Italia è prima di tutto un metodo progettuale. Nel nostro lavoro cerchiamo sempre di svelare l'anima di un progetto, di renderne visibile e tangibile la sostanza. La presenza della tecnologia e l'innovazione dei materiali sono tratti distintivi, terreno di sperimentazione fin dagli albori. Tra i primi a usare il Cristalplant, il cemento alleggerito UHPFRC utilizzato fino a quel momento solo in architettura, il cemento e i marmi spalmati per le superfici dei tavoli, operiamo sia con processi industriali che con procedimenti artigianali, in base al risultato che aspiriamo a ottenere.

The luxury of ideas.

We allow ourselves the luxury of ideas in the belief that there can be no project without prior thought and there are no thoughts without contamination from different perspectives. Hence our daily productive work is accompanied by ongoing research and dialogue with critics, designers and clients and with the most brilliant minds of the day. Pioneers of form destined to become icons of contemporary design, we believe in breaking the stereotypes and compositional frameworks and are open to be influenced and inspired by architecture, art and all other contemporary forms of expression.

Ci concediamo il lusso delle idee, nella convinzione che non ci sia progetto senza pensiero, e non ci sia pensiero senza contaminazione tra punti di vista diversi. Per questo affianchiamo al lavoro quotidiano sui prodotti un'attività continua di ricerca e confronto con critici, progettisti, clienti e con le menti più brillanti del nostro tempo. Pionieri di forme destinate a diventare icone della contemporaneità, crediamo nella rottura degli stereotipi e degli schemi compositivi e ci lasciamo influenzare dall'architettura, dall'arte e in generale dalle forme d'espressione più contemporanee.





Together with

967arch
Claudio Bellini
Francesco Bettoni
Simone Bonanni
Valentina Cameranesi
Michele Cazzaniga
Piergiorgio Cazzaniga
Ramón Esteve
Bruno Fattorini
Irene Goldberg
Pitsou Kedem
Xavier Lust
Jean Marie Massaud
Francesco Meda
Nendo / Oki Sato
Neuland Industriedesign
Jean Nouvel
Enrico Pompili
David Lopez Quincoces
Robin Rizzini
Francesco Rota
Leonardo Talarico
Victor Vasilev

designers



MDF Italia is a crucible of ideas. Ever ready to put the most creative intuitions to the test and challenge the material and design limits of furnishings and objects, the company works in tandem with the most talented Italian and international designers.

MDF Italia è una fucina d'idee. Pronta a mettere alla prova le intuizioni più creative e a sfidare i limiti materiali e progettuali di arredi e oggetti di design, collabora con i più talentuosi designer italiani e internazionali.

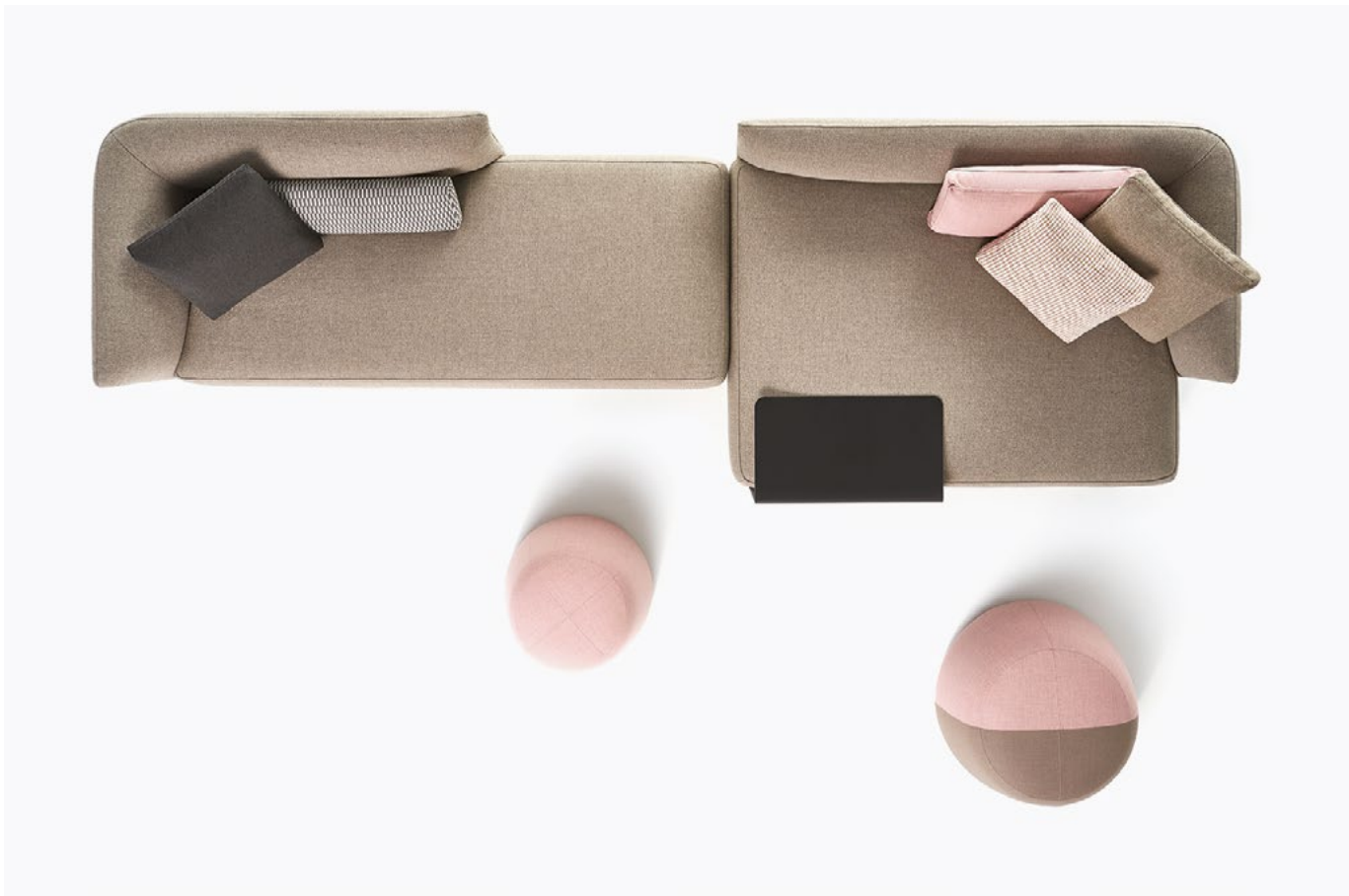

1

1 A contemporary sofa collection characterised by enveloping design - featuring large, soft cushions.

2 A sofa to be created according to one's needs and, thanks to the wide choice of fabrics, adaptable to any context.

Cosy
Cosy Curve
Cosy Island

Cosy collection

Designed by Francesco Rota

EN Designed by Francesco Rota, Cosy is a family of padded, modular elements capable of offering great comfort in different settings. Featuring modules and compositional freedom, it interacts with any context due to seating of different depths and lengths, backrests of different heights, small tables, accessories, and additional cushions. Cosy is also available in the Island version, with island elements that allow it to turn into a sofa for the middle of the room, and the Curve version, featuring a curved base and backrest, designed to become the natural focus for developing fluid spaces in modern homes or large open spaces in offices and hospitality locations.

IT Progettata da Francesco Rota, Cosy è una famiglia di imbottiti ad elementi componibili capaci di offrire grande comfort in contesti differenti. Caratterizzata da modularità e libertà compositiva, è in grado di dialogare con qualsiasi contesto grazie a sedute di differenti profondità e lunghezze, schienali ad altezze diverse, tavolini, accessori e cuscini addizionali. Cosy è disponibile anche nella versione Island, dotata di elementi a isola che le permettono di trasformarsi in un divano da centro stanza, e nella versione Curve, caratterizzata da basamento e schienale curvi, pensata per diventare il naturale baricentro attorno cui si sviluppano gli spazi fluidi della casa moderna o i grandi openspace del mondo office e hospitality.



2



1



1 The Cosy Island and Cosy Curve modules can be mutually combined to create numberless configurations.

2 Cosy Curve is ideal for creating an atmosphere of conviviality thanks to its dialoguing faces.



2



3



3 Cosy Island features great modularity and total freedom of composition.

4 Two-sided backrest for Island modules.



4





Fuji pouf



Tense Low Table





Flow Low Table



Fossil



Divide IT



Fossil



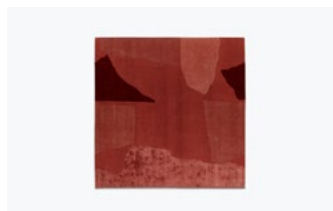

Frammenti



Pentagramma





1

1 A modular upholstered system consisting of sofa, pouf and corner and intermediate elements.

2 Two-seater sofa, over 200 colour variants available.



2

Mate

Designed by Robin Rizzini

EN A system of sofas and modular elements with frame in solid wood, elastic belts and a filling in non deformable variable density polyether and down, or in polyester wadding. The top stitched seam highlights the arms in the end, corner and special units. With the 95 cm large intermediate element and the 119 cm large end element with armrest, a sliding system allows to increase the seat depth by 18 cm for a better comfort. The fabric cover is specially made for maximum softness and covers every part of the sofa. Completely removable.

IT Sistema di divani ed elementi componibili realizzati con struttura in legno massello, cinghie elastiche ed imbottitura in polietere indeformabile a densità differenziata e piuma, o in ovatta di poliestere. La cucitura, ribattuta semplice con profilo in spessore, rimarca i braccioli degli elementi terminali, angolari e speciali. Grazie ad un sistema di scorrimento è possibile, nell'elemento intermedio da 95 cm e in quello terminale con bracciolo da 119 cm, aumentare la profondità della seduta di 18 cm per ottenere maggior comfort. Il rivestimento in tessuto è confezionato in modo da esaltarne la morbidezza, ricopre il divano in ogni sua parte ed è completamente rimovibile.



La Table Basse



1



1 Mia collection is characterized by a strong character enhanced by its tone-on-tone or contrasting trim.

2 Three-seater sofa with asymmetrical trim.



2



Mia

Designed by Francesco Bettoni

EN Compact, soft, and welcoming, Mia is a collection consisting of armchairs, sofas, and poufs featuring a thick profile with matching or contrasting upholstery. Designed by Francesco Bettoni, Mia grew out of the simple gesture of folding a cushion and creating a haven for moments of relaxation. The armchair is available in the fixed and in a 360° returning swivel base, while there are three small sized sofas suitable for any context.

IT Compatta, morbida e accogliente, Mia è una collezione composta da poltrona, divani e pouf caratterizzati da un profilo estetico a forte spessore, in abbinamento al rivestimento o a contrasto. Progettata da Francesco Bettoni, Mia nasce dal semplice gesto di piegare un cuscino e creare un rifugio per i momenti di relax. La poltrona è disponibile nella versione fissa o nella versione girevole a 360° con meccanismo di ritorno, mentre i divani sono tre imbottiti dalle dimensioni contenute, adatti a ogni contesto.

3 Mia collection is characterized by a soft compact armchair, sofas and pouf.



3



Flow Low Table



Flow Low Table

MDF Italia



Flow Pouf

Indoor book

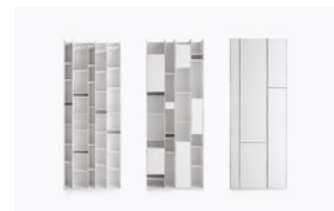

Random collection

Neil

Designed by Jean Marie Massaud

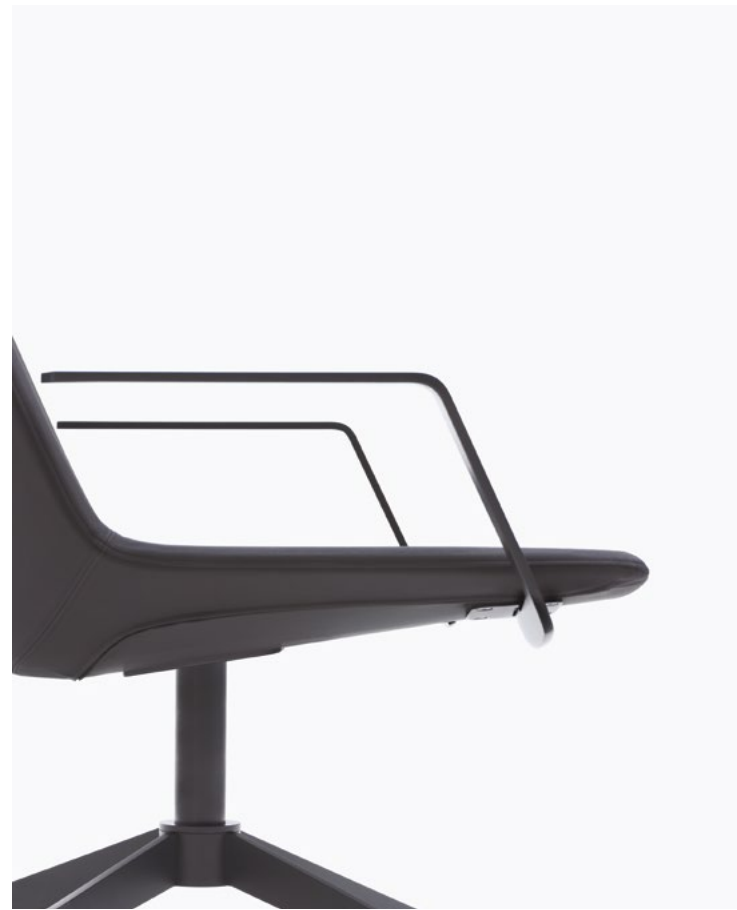

1

1 Focus on the 4-point star steel base with central frame.

2 A lounge chair available with two different bases, with or without armrests.



+

3 Premium armchair with high or low backrest.

EN Neil is a lounge chair celebrating lightness and competence. A radical language, a cosy comfort and an elegant technique that match surprisingly well with refined, natural finishes. Available in highback and low back version, with or without armrests. Four star steel structure, powder coated in the finishes matt white and lead black. Swivel 360°. Padded armchairs can be covered in fabric or leather. Not removable. Padded version, a load bearing shell in rigid polyurethane covered with polyurethane foam rubber. Polyester wadding completely covers the shell. Version with countershell, a load bearing shell in rigid polyurethane and liquid painted in the colours matt white and lead black. The colour of the shell matches with the one of the frame. Countershell in rigid polyurethane covered with polyurethane foam rubber with upholstery in polyester wadding.

IT Neil è una lounge chair che celebra leggerezza e competenza. Un linguaggio radicale, un comfort avvolgente ed un elegante tecnicismo, che si sposano con sorpresa a finiture raffinate e naturali. Disponibile nella variante alta e bassa, con o senza bracciolo. Basamento quattro razze, struttura in acciaio verniciato a polveri nelle finiture opache bianco o nero piombo. Girevole a 360°. Rivestimento in tessuto o pelle, non rimovibile. Versione totalmente imbottita, scocca portante realizzata in poliuretano rigido schiumato con gomme poliuretatiche espanse. Il rivestimento in ovatta di poliestere copre interamente la scocca. Versione con controscocca, scocca portante realizzata in poliuretano rigido e verniciato a liquido nei colori opachi bianco o nero piombo. Il colore della scocca segue quello del basamento. Controscocca in poliuretano rigido schiumata con gomme poliuretatiche espanse e rivestimento in ovatta di poliestere.



2



3

Neil Twist armchair

Designed by Jean Marie Massaud

EN Gritty, versatile, vibrant, yet at the same time an icon of essentiality. These are the main features of Neil Twist armchair whose eloquent name makes us sense that the manually braided wave is the project's protagonist, with a key detail – the contrasting internal cross stitch – that adds character to the overall view. In this version, Jean Marie Massaud's chair is highly versatile: it can actually be used both indoors and outdoors, where its neutral or very bright colours will be outstanding in parks and private gardens, meeting places, hotels and public spaces.

IT Grintosa, versatile, vibrante, ma al contempo icona di essenzialità. Queste le caratteristiche di Neil Twist, il cui eloquente nome lascia intuire che la corda intrecciata manualmente è la protagonista della seduta, con in più, un dettaglio – il punto a incrocio interno a contrasto – che aggiunge carattere a colpo d'occhio. In questa versione, la seduta di Jean Marie Massaud si distingue per la sua straordinaria versatilità: può infatti essere utilizzata con disinvoltura sia all'interno che in outdoor, dove i suoi colori, neutri o decisamente brillanti, caratterizzeranno parchi e giardini privati, luoghi di aggregazione, hotel e spazi pubblici.



1 In Neil Twist armchair, the load-bearing steel frame is wrapped in an exclusive polyester rope weave.

2 Available with or without armrests, with rope in 4 different colours.





Flow Low Table

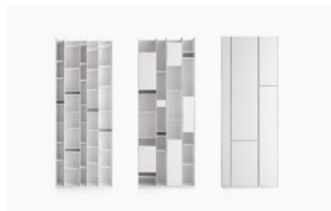

Random collection





1



2

1 A collection consisting of two or three-seater sofa and armchair.

2 The essential aluminium frame supports the soft cushions.

Yale
Yale X

Yale collection

Designed by Jean Marie Massaud

EN Jean Marie Massaud's latest creations were conceived for a functional and contemporary home, expressing a style and a way of living in which formal simplicity doesn't exclude creativity, quality, innovation and a sophisticated aesthetics. The designer extends Yale X's project idea to the night area, proposing again Yale's softness and comfort for the headboard, as well as the refined aesthetics of the sofa's stand as the hallmark of the bedframe. The bed is offered in two different versions – with low headboard H90 cm and with high headboard H103 cm with fabrics or leather coating (completely removable), to meet different comfort needs and taste requirements. The contrasting seams characterise and identify the Yale Bed collection, only for the high headboard variant.

IT Le ultime creazioni di Jean Marie Massaud sono pensate per una casa funzionale e contemporanea, espressione di uno stile e di un modo di abitare in cui la semplicità formale non esclude creatività, qualità, innovazione ed un'estetica ricercata. Il designer declina l'idea progettuale del divano Yale X alla zona notte, riproponendo la morbidezza ed il comfort dell'imbottito per la testiera del letto e la raffinata estetica del basamento del divano quale elemento distintivo del giroletto. Yale Bed viene proposto in due differenti versioni: a testata bassa H90 cm e a testata alta H103 cm con rivestimento in tessuto o pelle (completamente removibile) per soddisfare diverse esigenze di comfort e di stile. Caratterizza e identifica la collezione Yale Bed, nella sola variante a testata alta, la cucitura a contrasto.



Yale



Yale X

3 Awarded with the Compasso d'Oro in 2011.



3



4

4 Armchair and sofa with strong personality and large cushions, providing considerable comfort.

5 Available in two different seat depths, and in two different backrest heights, which guarantee a comfortable sitting position.



6

6 In the Yale X version the upholstery in fabric or leather covers every part of the sofa and is completely removable.

7 The contrasting seams characterise and identify the Yale X collection, only for the high backrest variant.



5



7





Yale Low Table



Flow Low Table



Melody

Designed by Neuland Industriedesign

EN An individual flexible and customised furnishing solution, not just a simple bookcase. This is Melody's visiting card, offering a comfortable and eye catching horizontal storage, also for big objects. The layout of the shelves with its gritty graphic pattern, sends an idea of movement, a sort of discreet waving. The module is single, but always vertically revertible, which allows to give horizontal continuity or discontinuity to the shelves, by combining more modules. By flanking more units, you can create large sized configurations. Offered either in a monochromatic version or with contrast backrest to create unique environments.

IT Un'espressione individuale d'arredo flessibile e personalizzabile, non una semplice libreria. Questo il biglietto da visita di Melody, che offre un confortevole e accattivante contenimento in orizzontale, anche per grandi oggetti. La disposizione dei ripiani dal grintoso pattern grafico veicola movimento, una sorta di discreto ondeggiare. Il modulo è unico, ma sempre reversibile verticalmente, il che consente di conferire continuità o discontinuità orizzontale ai ripiani, accostando più moduli. Per accostamento è possibile realizzare configurazioni di grandi dimensioni. Disponibile nella versione monocromatica oppure con schienale a contrasto per creare ambienti unici.



1 A vertically reversible bookcase allowing the creation of compositions with continuous

or discontinuous shelves by combining several modules.



1



Random 2C/3C
 Random 5C
 Random Box
 Random Cabinets
 Random Wood

Random collection

Designed by Neuland Industriedesign

EN A timeless icon of the MDF Italia collection, Random has revolutionised the bookcase concept by transforming a functional container into a design sculpture. A product that gives rhythm to space thanks to the irregular structure of the shelves, only 6 mm thick, played out in different heights, designed to house not only books, but also objects that tell the story and personality of each individual. Over the years Random has evolved by expanding the family with the 2C-3C, Random Box and Cabinet versions, meeting the most diverse market and usage requirements. The collection offers great compositional freedom, allowing the various modules and finishes available to be combined to create almost infinite configurations characterised by great lightness.

IT Icona senza tempo della collezione MDF Italia, Random ha rivoluzionato il concetto di libreria trasformando un contenitore funzionale in una scultura di design. Un prodotto che ritma lo spazio grazie alla struttura irregolare dei ripiani di soli 6 mm di spessore giocati su diverse altezze, atti ad ospitare non solo libri, ma anche oggetti che raccontano la storia e la personalità di ogni individuo. Negli anni Random si è evoluta ampliando la famiglia con le versioni 2C-3C, Random Box e Cabinet, incontrando le più svariate esigenze di mercato e di utilizzo. La collezione offre un'ampia libertà compositiva, permettendo di combinare i vari moduli e finiture a disposizione per dare vita a pressoché infinite configurazioni caratterizzate da grande leggerezza.



- 1 Random, a sculptural bookcase with an extraordinary irregular structure.
- 2 Random, Random Box and Random Cabinet.





3



4

3 2C and 3C modules make Random flexible and adaptable to all spaces.

4-5 Overview of available Random 2C and 3C colours.



5

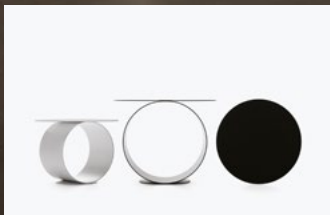

Metodo



Cosy Island



6



6 Bookcase made with 6mm thick panels of medium density fiberwood in canaletto walnut finish.



Flow Pouf



Neil Twist armchair



Arpa Low Table

Randomissimo

Designed by Neuland Industriedesign

EN Randomissimo represents the involution of the Random concept. It accompanies the ripe sign of the present collection towards its total subtraction, turning it into a simple graphic line, an apostrophe on the wall. A piece of furniture for personal items: featuring a reduced overall size, it is changeable, playful, complementary and modular. Randomissimo embodies so well MDF Italia's identity principles: subtraction, formal and technical simplicity and strong emotional imprint. A product that immediately unveils, through its playful modularity and colors, the capability of developing small aggregations, as well as endless compositions with a surrealistic spirit.

IT Randomissimo rappresenta l'involuzione del concetto Random; accompagna il "segno maturo" dell'attuale collezione alla sua totale sottrazione, trasformandolo in un semplice tratto grafico, un apostrofo sulla parete. Un complemento per oggetti personali: contenuto nelle dimensioni, mutabile, ludico e modulare. Randomissimo è l'espressione dei principi identitari di MDF Italia: sottrazione, semplicità formale/tecnica e forte impronta emozionale. Un prodotto che svela immediatamente, attraverso la sua componibilità ludica e le sue cromie, la capacità di realizzare piccole aggregazioni o infinite composizioni dallo spirito surrealistico.



1

1 A simple graphic line, an apostrophe on the wall.

2 Two different modules available in two matt painted finishes.



3 Through its playful modularity and colours Randomissimo allows endless compositions to be created.



2



3



1

Randomito

Designed by Neuland Industriedesign

EN A graphic sign on the wall that catches the eye. A small but endearing hanging bookcase, able to confer dynamism to any environment and embellish it as an artwork. Neuland Industriedesign conceived a bookcase evoking movement and lightness, whose silhouette is unmistakable: one in a kind, it is inspired to the "progenitor" Random, representing one of its evolutionary paths. Wonderful in residential contexts, Randomito lends itself excellently to business spaces. Single and vertically reversible module, Randomito can be used both individually and by aggregation, thus getting plenty of customised configurations.

IT Un segno grafico sulla parete che cattura lo sguardo. Una piccola libreria pensile dal grande impatto estetico, in grado di conferire dinamismo a qualsiasi ambiente e di impreziosirlo come un'opera d'arte. Neuland Industriedesign ha immaginato una libreria che evoca il movimento e la leggerezza, dalla silhouette inconfondibile: unica nel suo genere, s'ispira all'iconica "capostipite" Random, rappresentando uno dei suoi percorsi evolutivi. Splendida in contesti residenziali, Randomito si presta egregiamente anche in ambienti contract. Randomito è un modulo unico e reversibile verticalmente, si può utilizzare sia singolarmente che per aggregazione, ottenendo così numerose configurazioni personalizzate.



1 With Randomito, the wall becomes dynamic, creative, versatile.

2 Two or more Randomito can be placed side by side to create many configurations.



2



Minima 3.0
 Ground-resting
 Minima 3.0 Cabinets
 Minima 3.0 Hanging
 Minima 3.0 Room Divider
 Minima 3.0 Sideboard
 Minima 3.0 Sketch
 Minima 42

Minima collection

Metrica designed by Bruno Fattorini

EN Honourable mention at the 18th ADI Compasso d'Oro in 1998, Minima is an aluminium bookcase system consisting in three key elements shelf, upright, and container that can be freely configured. Designed by Bruno Fattorini and featuring light, essential lines, Minima has evolved over the years, becoming a versatile, adaptable furnishing system available in different heights and finishes. It is capable of joining multiple functions, with Room Divider, a room dividing bookcase to elegantly separate environments, and Sketch, a collection of wall mounted bookshelves that offer the utmost expressive freedom in all areas of the home.

IT Menzione d'onore al XVIII Compasso d'Oro ADI nel 1998, Minima è un sistema di librerie in alluminio composto da tre elementi cardine: mensola, montante, contenitore che possono essere configurati liberamente. Disegnata da Bruno Fattorini e caratterizzata dall'essenzialità e dalla leggerezza delle linee, Minima nel corso dei decenni si è evoluta, trasformandosi in un sistema d'arredo versatile e adattabile, disponibile in diverse altezze e finiture e capace di unire più funzioni, tra cui quella di Room Divider, una libreria divisoria a centro stanza per separare gli ambienti in modo elegante, e Sketch, una collezione di librerie pensili che offre la massima libertà espressiva in tutte le aree della casa.



+
 Minima
 3.0



+
 Minima
 42

1 An adaptable furnishing system available in different heights and finishes capable of joining multiple functions.

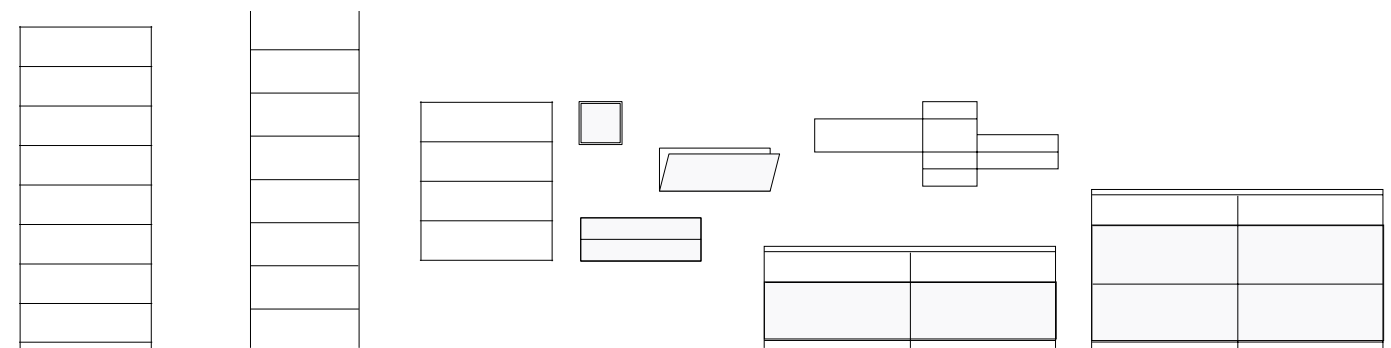



Minima 3.0
Ground-resting

EN An aluminium profile only 15 mm thick draws a simple and essential architecture that combines lightness and technological innovation. Minima 3.0 in the ground-resting version is the archetypal bookcase: the three pivotal elements - shelf, upright, container - are assembled together using an invisible joint system and can give rise to infinite interpretations. In the ground-resting version, Minima 3.0 is also available with a hidden electrified frame.

IT Un profilo in alluminio di soli 15 mm di spessore disegna un'architettura semplice ed essenziale che coniuga leggerezza e innovazione tecnologica. Minima 3.0 nella versione ground-resting è l'archetipo della libreria: i tre elementi cardine - mensola, montante, contenitore - sono assemblati tra di loro con l'utilizzo di un sistema di giunzione invisibile e possono dar vita a infinite interpretazioni. Nella versione a terra Minima 3.0 è disponibile anche con binario elettrificato nascosto all'interno del montante.



1 Minima 3.0 ground-resting version with drawers and open cabinets.



1



Mia armchair



2

2 The structure is 15 mm thick only, to propose an increasingly minimal yet strong identity.

3 Minima 3.0 features an aluminium structure that can be customised with different accessories.



4

4 The modularity of Minima 3.0 allows the creation of large compositions.

5 Only in the ground-resting version, Minima 3.0 is available with an adjustable light.



3

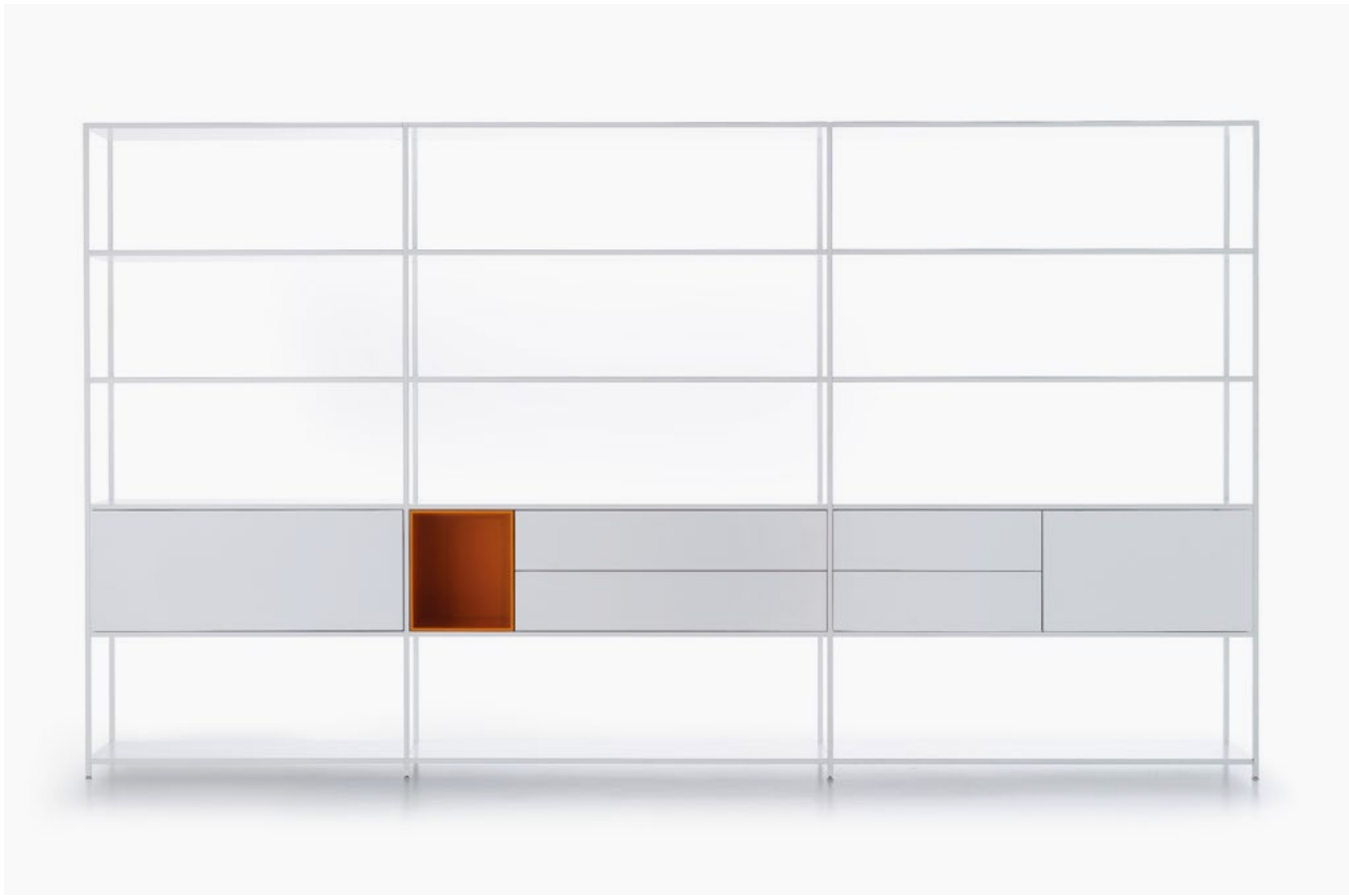

5



1

1 Door equipped with downward compass opening, with retractable mechanism with a stainless-steel cable, shock-absorbing system.



2

2 Door with innovative pantograph opening and closing mechanism, completely concealed inside the side panels, for extreme ease of opening.

3 Open cabinets, new color.

4 Rear-lacquered glass in white, graphite grey, shadow grey, or pearl nickel to match the unit structure



3

100

Minima collection



4

Systems

Minima 3.0 Cabinets

EN The balance of solids and voids in the Minima 3.0 bookcase is determined by the use of storage units, open cabinets and drawers positioned at free choice inside the structure. In addition to the classic lacquered version, drop leaf doors and drawers are available in rear lacquered glass and grooved Cimento®, a special cement finish created in collaboration with the Veneto based company. The pantograph opening and closing mechanism, completely concealed inside the side panels, allows for extreme ease of opening, enabling the door to reach a length of 120cm.

IT Il rapporto tra pieni e vuoti nella libreria Minima 3.0 è determinato dall'utilizzo di contenitori con ribalta, vani a giorno e cassetti posizionati in appoggio all'interno della struttura. Oltre alla classica versione laccata, le ante dei contenitori a ribalta e dei cassetti sono disponibili nella finitura in cristallo retrolaccato e cemento ordito, una speciale finitura cementizia realizzata in collaborazione con l'azienda veneta Cimento®. Il meccanismo di chiusura a pantografo, completamente nascosto all'interno della spalla laterale, consente un elevato comfort nel movimento di apertura permettendo all'anta di raggiungere la lunghezza di 120cm.



5 Cimento® is a revolutionary concrete compound that gives a solidly consistent appearance to surfaces and surprising texture.



5

MDF Italia

Indoor book

101







1

Minima 3.0 Hanging

EN Minima 3.0 becomes even lighter in the hanging version. The invisible wall mounting system disappears inside the uprights, allowing this bookcase to leave a graphic mark on the wall. The great flexibility of this system makes it possible to create compositions of various sizes, developed both in height and width, and which can be equipped with drawer units or flap doors.

IT Minima 3.0 si fa ancora più leggera nella versione pensile. Il sistema di fissaggio a muro invisibile scompare all'interno dei montanti permettendo a questa libreria di lasciare un segno grafico sulla parete. La grande flessibilità di questo sistema permette di dare vita a composizioni di svariate dimensioni, sviluppate sia in altezza che in larghezza, e attrezzabili con contenitori a cassetti o ante a ribalta.



1-2 Frames and shelves are assembled together by using a concealed joining system, giving

the structure stability and a special load resistance.

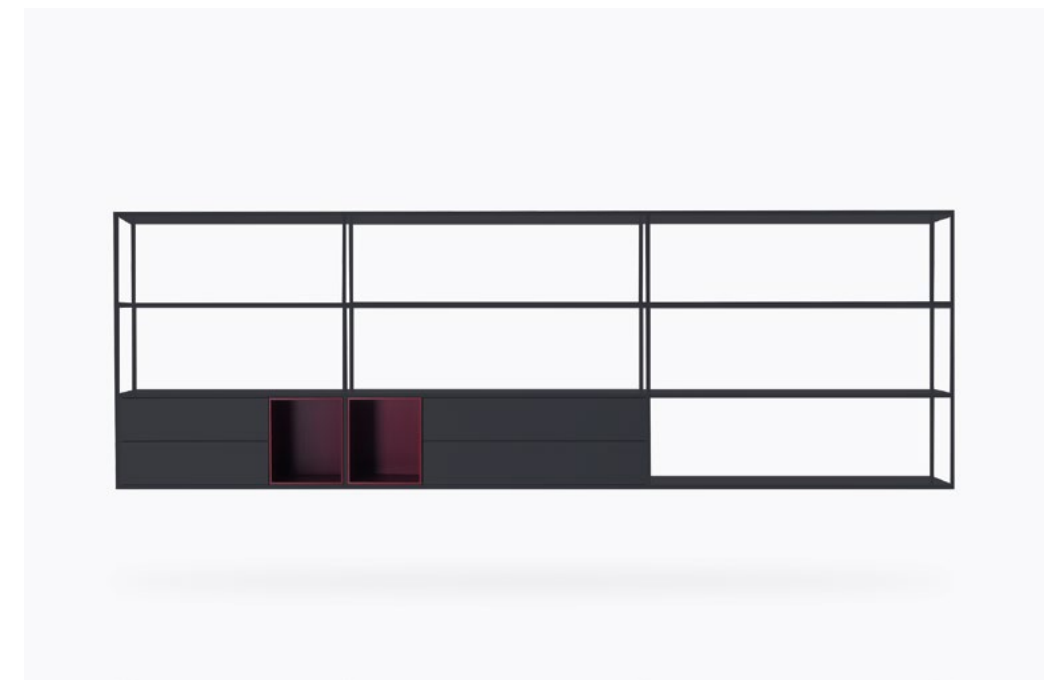

2



1

Minima 3.0 Room Divider

EN Minima 3.0 Room Divider, is an extremely flexible system, which reaches 3 meters in height. It was born to separate, and it divides in a functional way both residential and contract spaces. More than just a bookshelf, but a versatile system to adapt to different end uses and to meet different customers' needs. The Room Divider version comes in ten heights and max six columns as per compositions.

IT Minima 3.0 Room Divider è un sistema divisorio di grande flessibilità, che può raggiungere i 3 metri di altezza. Nata per separare, divide in modo funzionale sia gli spazi residenziali che professionali. Più di una semplice libreria, ma un vero e proprio sistema versatile che si adatta a svariate ipotesi d'uso per venire incontro a differenti esigenze dei fruitori finali. Disponibile in dieci altezze e massimo sei campate.



1-2 In the Room Divider version, Minima 3.0 lends itself as a room divider bookcase to separate environments.

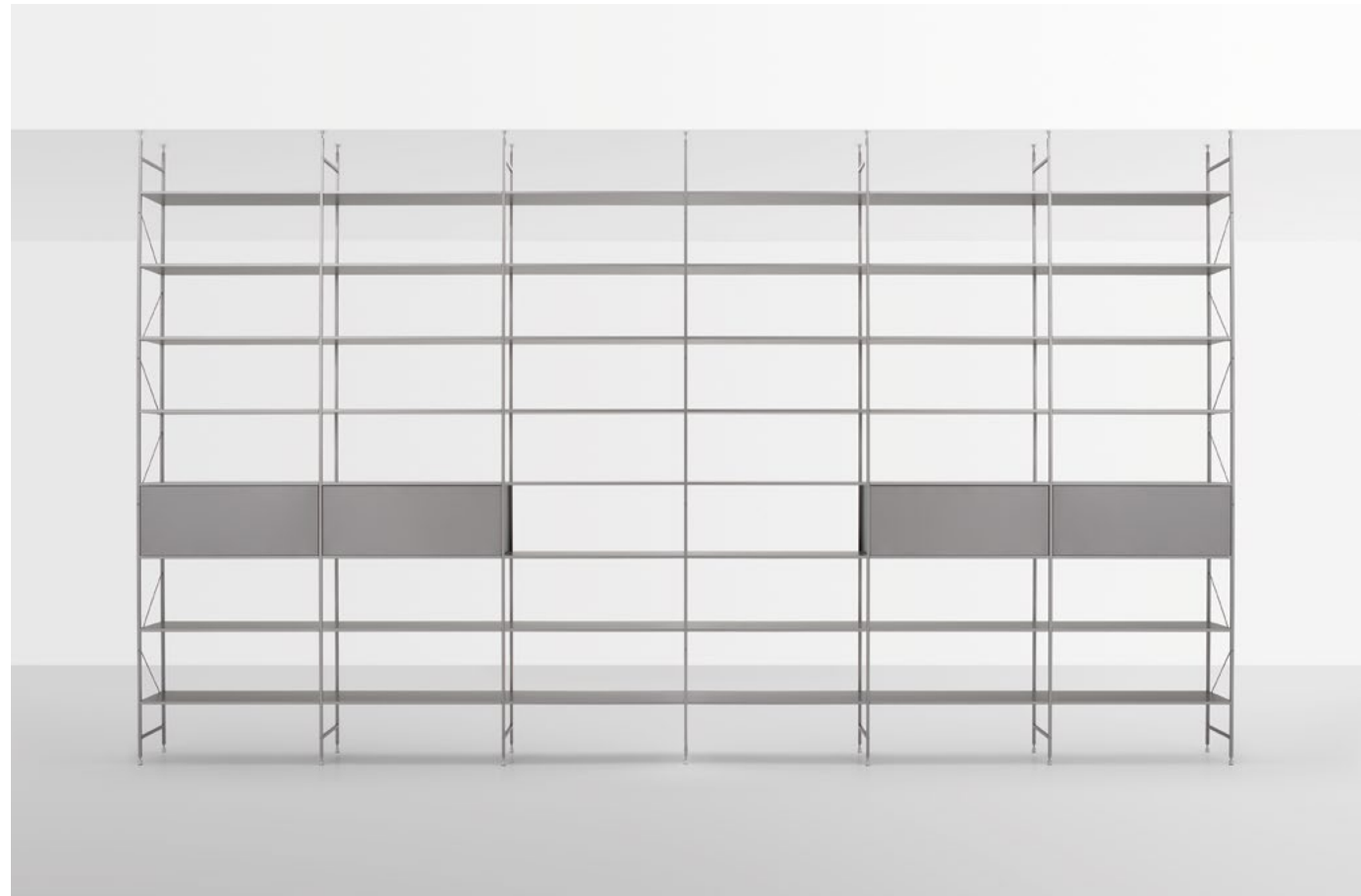

2





Minima 3.0 Sketch

EN The Minima 3.0 Sketch version is a collection of hanging bookcases that offers maximum expressive freedom in all the areas of the house. Available in several configurations of different width, height and colours options, Minima 3.0 Sketch organizes your spaces in a creative and functional way. Available in a monochromatic version or with a material top, it can be equipped with storage units with door, flap opening door, drawers, or open cabinets. A versatile and dynamic system, at home or in the office, which thanks to the possibility of customization responds to the different needs of style, environment, and personality.

IT Minima 3.0 nella versione Sketch è una collezione di librerie pensili che offre la massima libertà espressiva in tutte le aree della casa. Disponibile in diverse configurazioni predefinite di diversa larghezza, altezza e colori, Minima 3.0 Sketch organizza in modo creativo e funzionale gli spazi. Disponibile nella versione monocromatica oppure con top materico, può essere accessoriata con vani a giorno e contenitori ad anta ribalta oppure con cassetti. Un sistema versatile e dinamico che grazie alle possibilità di personalizzazione risponde alle diverse esigenze di stile, ambiente e personalità.



1-2 A collection of hanging bookcases that offers maximum expressive freedom.

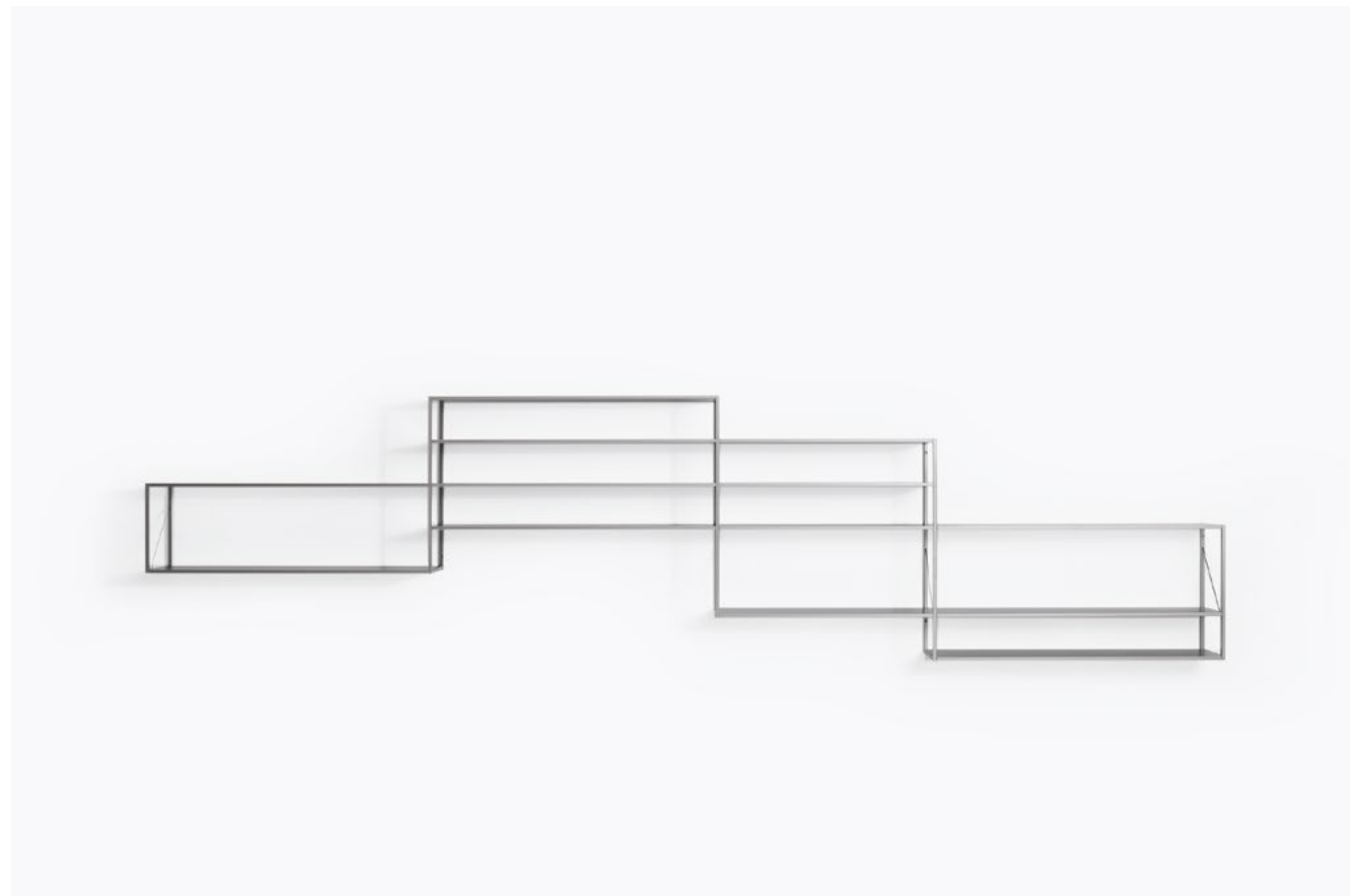



1

Minima 3.0 Sideboard

EN The Minima 3.0 Sideboard collection organizes spaces and contributes to the definition of the environment. The Sideboard version is a cabinet perfect to help in different functions and offers an additional storage space. Essential lines and a timeless character distinguish this piece of furniture that in the living room or entrance can serve as a support surface, to hold books or objects, while in the dining room it is a valid solution to put services and accessories in order. Also suitable in the centre of the room to divide space, it is available in different configurations with two heights and can be customised with storage units and drawers.

IT Minima 3.0 nella versione Sideboard è una madia che si presta a diverse funzioni e offre uno spazio di contenimento aggiuntivo. Linee essenziali e carattere senza tempo contraddistinguono questo complemento d'arredo che in soggiorno o in ingresso può servire come piano d'appoggio, per contenere libri od oggettistica, mentre nella sala da pranzo costituisce una valida soluzione per riporre in ordine servizi e accessori. Ideale anche a centro stanza per dividere gli spazi, è disponibile in diverse configurazioni con due altezze e può essere personalizzata con contenitori e cassetti.



1-2 Minima 3.0 Sideboard combines function and aesthetics.



2

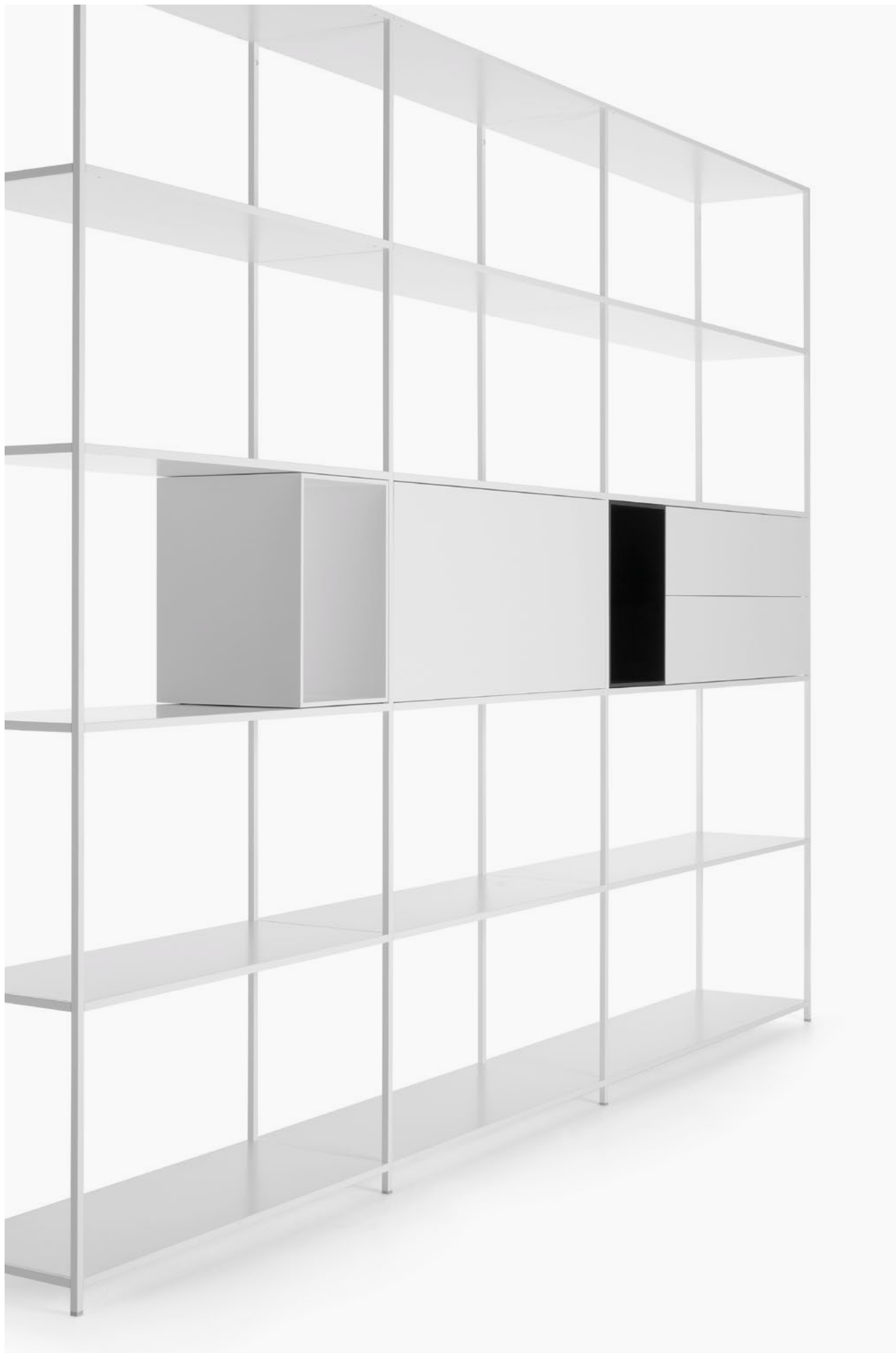

Minima 42

EN The considerable span of the shelf in extruded aluminium combined with the joining system, have allowed to develop the system in length, making it modern and adjustable to any kind of environment. Minima 42 is available in the ground resting variant (in 5 heights), always with a 33 cm depth. Uprights and shelves made of matt lacquered white and graphite grey extruded aluminium. Modular and flexible even thanks to the kinds of storage units. These can be with door, flap opening doors or drawers. They are simply resting inside the structure and are repositionable quite easily, thus allowing to meet any storage requirements as desired. Nominal lengths of cabinets: 30, 60, 90 cm, height 42 cm and depth 33 cm. Available in a matt lacquered microgoffered finish as well as in the natural wood variant, natural grey wood and natural black wood. Units with flap opening door and twodrawer are available with lock.

IT La notevole campata del ripiano, in estrusione di alluminio, abbinata al sistema di giunzione, hanno permesso una distensione orizzontale del sistema, rendendolo moderno e adattabile a qualsiasi genere di ambiente. Minima 42 è disponibile nella variante terra (cinque altezze) sempre nella profondità 33 cm. Montanti e ripiani realizzati in estrusione di alluminio, finitura verniciata opaca nei colori bianco e grigio grafite. I moduli (ribalta, cassetti e moduli a giorno) sono semplicemente in appoggio all'interno della struttura e riposizionabili con estrema facilità; questa caratteristica permette di variare a piacere e a necessità le situazioni di contenimento. I contenitori, nelle larghezze nominali 30, 60 e 90 cm, altezza 42 cm e profondità 33 cm, sono in laccato opaco microgoffrato o nella variante essenza in legno naturale, naturale grigio e naturale nero. I contenitori con ribalta e cassetti sono disponibili anche nella variante con serratura.



1 Minima 42 is available in the ground-resting variant.

2 Modular and flexible thanks to the storage units.

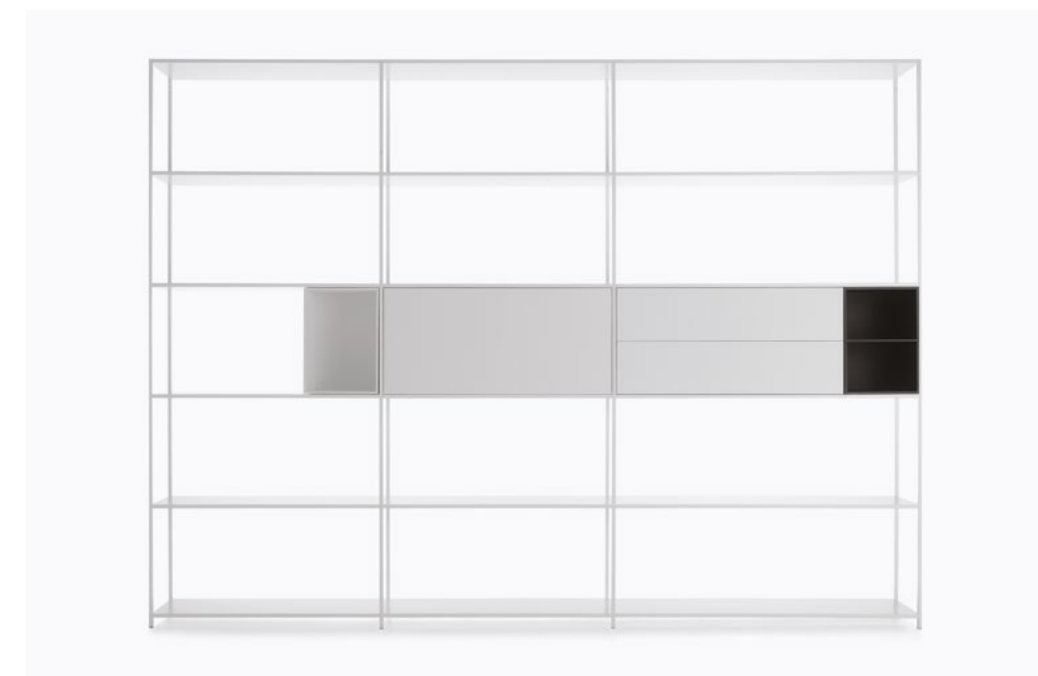



1

Pentagramma

Designed by Pitsou Kedem

EN Pentagramma is the new living system designed by Pitsou Kedem for MDF Italia, a design with a strong personality that interprets the concept of the day system with sophistication by focusing on the value of lightness. Surprisingly simple to compose and install, the design develops from an extruded aluminium panel fixed to the wall, on which various elements, containers or shelves are hung. Its name was inspired by its construction: the wall-mounted back panel to which the accessories are hung to create the composition looks like a music stave or pentagramma in Italian, on which the notes are written to compose a tune. Extremely flexible and versatile, this system offers the possibility of reconfiguring the layout over time. Just a few elements are enough to obtain infinite combinations that fulfil different functions and situations of use, fitting seamlessly and with versatility into all residential and contract environments: in fact, it offers a valid storage solution for walls in the living area and office, but also for creating compositions in the sleeping area.

IT Pentagramma è il nuovo sistema a giorno firmato by Pitsou Kedem per MDF Italia, progetto fortemente identitario che interpreta in maniera sofisticata il concept di sistema a giorno mettendo al centro il valore della leggerezza. Caratterizzato da una sorprendente semplicità compositiva e d'installazione, il progetto si sviluppa a partire da un pannello in estruso di alluminio vincolato al muro, al quale si agganciano in sospensione diversi elementi, vani a giorno o mensole. Ed è proprio la sua costruzione ad averne ispirato il nome: lo schienale a muro su cui si applicano gli accessori per creare la composizione ricorda un pentagramma su cui si scrivono le note per comporre una melodia. Estremamente flessibile e versatile, questo sistema offre la possibilità di riconfigurare il layout nel tempo. Pochi elementi sono sufficienti per ottenere infinite combinazioni che assolvano diverse funzioni e situazioni d'uso, declinandosi in maniera trasversale a tutti gli ambienti residenziali e contract: rappresenta infatti una valida soluzione per attrezzare pareti nella zona giorno e in ufficio, ma anche per dare vita a composizioni nella zona notte.



1 A flexible and versatile system, simple to compose and install.

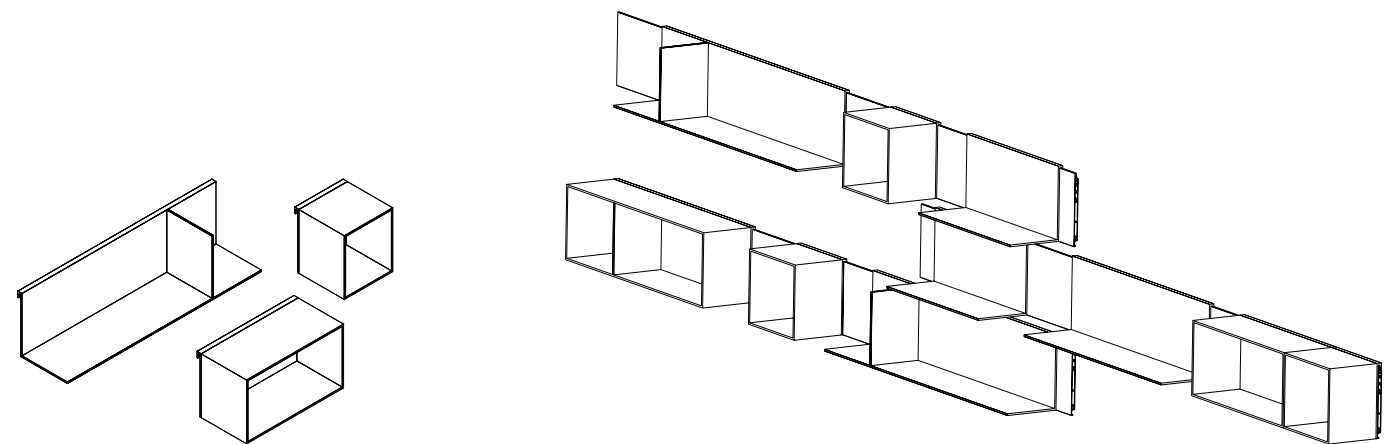



Lofty







1

Axy

Designed by Claudio Bellini

EN Lightness combined with dynamic perception of suspension is the theme developed by the design of the new table system Axy. A basic architecture in which the original design of the two structural bridges, entirely made of aluminium, recomposes the tensions and strength lines with expressive efficacy. A thin top completes the table, conveying an overall aerial impression underpinned by reassuring stability. Available in various configurations, with a wide choice of materials and finishes Axy naturally adapts to a broad range of interpretations both for indoor and outdoor use, from the dining-table to the working desk. Rectangular tables available in 15 sizes and various depths, height 73 cm, in the types and configurations: Axy and Axy Comfort.

IT La ricerca della leggerezza combinata alla percezione dinamica della sospensione è il tema sviluppato nel disegno del nuovo sistema di tavoli Axy. Un'architettura essenziale, dove l'originale disegno dei due ponti strutturali, interamente realizzati in alluminio, ricompono con efficacia espressiva tensioni e linee di forza in campo. Un piano sottile completa il tavolo, conferendo all'insieme un'immagine aerea e allo stesso tempo di rassicurante stabilità. Disponibile in diverse configurazioni, grazie ad un'ampia scelta di materiali e finiture. Axy si presta con naturalezza a diverse interpretazioni sia in ambito indoor che outdoor, dal tavolo da pranzo alla scrivania. Tavoli rettangolari disponibili in 15 dimensioni e varie profondità, altezza 73 cm, nelle tipologie e configurazioni di Axy e Axy Comfort.



1 Detail of the Axy frame.

2 A table system available in a variety of sizes to suit all uses.



2



Aiku collection



1

1 The extension tops slide into the tray, equipped with non-scratch lining.

2 The length can be increased from 50 to 100cm.



2

Extension

Designed by Bruno Fattorini

EN The range of Extension tables excellently combines the aesthetics of MDF Italia table with the functionality of a an extension product, thus meeting market demands. The system's flexibility is emphasized by the presence of one or two extension tops measuring 50cm each and resting on the frame's slide rails. According to the customer's needs, the nominal length of the table can be increased from 50 to 100 cm, to accommodate an unexpected guest or to adapt at best to the environment.

IT La serie di tavoli allungabili Extension, coniuga sapientemente l'estetica del tavolo MDF Italia con la funzionalità di un prodotto allungabile, rispondendo appieno alle esigenze degli spazi moderni. La flessibilità del sistema viene enfatizzata dalla presenza di uno o due piani d'allungo, da 50 cm cadauno, posizionati in appoggio ai binari di scorrimento della struttura; in base alla necessità è possibile aumentare da 50 a 100 cm la lunghezza nominale del tavolo, per poter accogliere l'ospite inatteso e adattarsi all'ambiente.



+

3 Table with one extension top.



3



1

La Grande Table

Designed by Xavier Lust

EN A table made from a single curved and painted aluminium sheet, joint-free shape: La Grande Table surprises thanks to its slender proportions and lightness. The design of the table and the peculiarity of the bending in the aluminium sheet produce structural curves in the tabletop, both in length and transversally, that define its identity. La Grande Table offers different size options: thanks to the reinforcement beams incorporated in the internal structure, it reaches 4.4m in length, maintaining a thickness of only 6 mm. Available in lacquered aluminium, matt or glossy white lacquered, La Grande Table fits into indoor and outdoor contexts such as gardens, terraces and dehors. Linear style and timeless design allow La Grande Table to adapt to different styles of furniture and to integrate with the surrounding environment.

IT Un tavolo realizzato da un unico foglio di alluminio, curvato e verniciato, privo di giunture: La Grande Table sorprende grazie alle sue proporzioni slanciate e alla sua sottigliezza. Il disegno del tavolo e le particolari caratteristiche della piegatura della lastra realizzano delle curvature strutturali del piano, sia longitudinalmente che trasversalmente, che ne definiscono l'identità. La Grande Table prevede diverse varianti dimensionali: grazie alle travi di rinforzo incorporate nella struttura interna raggiunge i 4,4m di lunghezza conservando uno spessore della lastra di solo 6 mm. Disponibile nella variante in alluminio naturale oppure bianco opaco e lucido, La Grande Table si inserisce in contesti indoor e outdoor come giardini, terrazze e dehors. Stile lineare e design senza tempo permettono a La Grande Table di adattarsi a diversi stili di arredamento e di integrarsi con l'ambiente circostante.



+

1 La Grande Table with Le Banc bench, both designed by Xavier Lust.

2 La Grande Table is made from a single curved and painted aluminium sheet.



2



Flow collection



1



2

1-2 The aluminium structure accommodates tops in different materials: ceramic, glass and fenix.

3-4 Aluminium frame available in two matt painted variants.



3



4



+

5 Upon request, the tables are also available in the version equipped with 1 or 2 top-access and under top cable tray.



5

Lim 3.0

Metrica designed by Bruno Fattorini

EN Lim 3.0, a makeover of the Lim iconic family, renews and turns into a light and thin table, with a more up-to date and modern identity. The structure contained in the sections can receive different materials to offer an alternative option to monochromatism and single material structure. Tops are built-into the frame and are available in white or black lacquered tempered glass; ceramic in matt-coated variant in light grey or black Calce, medium grey Pietra di savoia and corten; Fenix in the matt variant in the following colours: white, black and medium grey. Tables are also available in the version equipped with 1 or 2 openings for cable access and an undertop cable tray. A table composed of top, legs and a perimeter frame in extruded aluminium, available in epoxy powder matt painted version in white and graphite grey shades. Tops are built-into the frame and need no fittings.

IT Lim 3.0, restyling dell'iconica famiglia Lim si rinnova trasformandosi in un tavolo leggero, sottile e dall'identità più attuale. La struttura è in grado di accogliere materiali differenti per ottenere un'alternativa al monocromatismo e al monomaterico. I piani sono ad incasso in cristallo temperato laccato nei colori bianco e nero; ceramica opaca nelle varianti calce grigio chiaro o nero, Pietra di Savoia e corten; Fenix bianco, nero e grigio medio. I tavoli sono disponibili anche nella versione attrezzata con 1 o 2 antine passacavi e vaschette 'sotto-top' portacavi. Tavolo composto da piano portante, gambe e struttura perimetrale in estruso di alluminio, disponibile nella versione verniciata opaca a polvere epossidica nei colori bianco e grigio grafite. I piani sono ad incasso e non hanno necessità di alcuna ferramenta di fissaggio.





Achille collection





NVL Table

Designed by Jean Nouvel Design

EN A table made from only one material with contemporary lines that convey strong personality. NVL Table is a project created by the french designer Jean Nouvel for MDF Italia and that takes the name literally. The distinctive traits of its architecture manifest fully in this table to highlight stylistic elements that have always distinguished the works of Jean Nouvel: pure geometric shapes, formal lightness, graphic marks, and rigour. The simplicity of the shapes plays harmoniously on the contrast with the solidity of the material: the table top appears thin and light and seems to float above the base. The central support consists of two volumes that are tapered on the upper part to create two symmetrical bases that support the top. The effect recalls a trilithon, a structure formed from two vertical elements and a third positioned horizontally on top.

IT Un tavolo monomaterico, dalle linee contemporanee, connotato da una forte personalità. NVL Table è un progetto firmato dal designer francese Jean Nouvel per MDF Italia e che ne prende letteralmente il nome. I caratteri distintivi della sua architettura si manifestano pienamente in questo tavolo ed esaltano gli elementi stilistici che da sempre contraddistinguono il lavoro di Jean Nouvel: forme geometriche pure, leggerezza formale, graficità, rigore. La semplicità delle forme dialoga armoniosamente con la solidità del materiale in un gioco di contrasti: il piano del tavolo appare sottile e leggero e sembra galleggiare sopra il basamento. Il sostegno centrale è composto da due volumi che si assottigliano verso l'alto e che creano due basi simmetriche a sostegno del top, richiamando così il principio del trilito, una struttura formata da due elementi verticali e un terzo appoggiato orizzontalmente.



1 NVL Table collection overview.



2

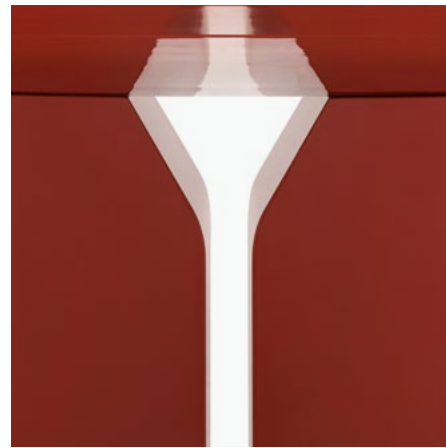

3

2 The central support is composed of two volumes that thin upwards.

3 Available in gloss and matt lacquered variants, and in materic finishes.

4 A mono-material table with contemporary lines and characterised by a strong personality.



4



Achille collection





Universal collection



Neil collection





Offset

Designed by Francesco Meda
David Lopez Quincoces

EN The new Offset table designed by the Meda-Quincoces duo finds its poetic ethos in minimalism. The protagonist of the design is the purity of the material used, a fundamental feature of the MDF Italia heritage: here it is brushed anodised aluminium. The simplicity of the lines, carried to a wide range of sizes, including extra-large, combines lightness and a statement look in the chameleonic, universal style of an industrial material capable of blending seamlessly into various domestic and contract contexts. The Offset table system is ideal for both indoor and outdoor use, and it is characterized by extreme flexibility. It can feature tops in various materials, such as back-painted glass, aluminium or reconstructed stone.

IT Il tavolo Offset disegnato dalla coppia Meda-Quincoces individua nella riduzione ad minimum la sua poetica. Protagonista è la materia pura, tratto fondamentale dell'heritage MDF Italia, che qui si esprime nell'alluminio anodizzato con finitura spazzolata. La semplicità delle linee portata su una vasta gamma di misure, anche extra-large, unisce leggerezza e forza attraverso il linguaggio universale e camaleontico di un materiale dall'anima industrial che è capace d'inserirsi in maniera silenziosa all'interno di diversi contesti domestici e contract. Il sistema di tavoli Offset trova la sua collocazione nell'indoor come nell'outdoor, ed è caratterizzato da un'estrema flessibilità, grazie anche all'inserimento di piani in diversi materiali come vetro retroverniciato, alluminio o pietra ricostruita.



1 Offset table: a pure combination of elegance, materiality and lightness.

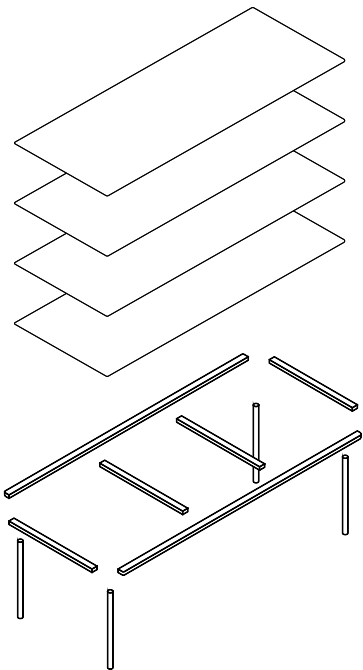



2



3

2 The frame is composed of only two extruded elements joined together fluidly by way of a high-precision mechanical processing method.

3 100% recyclables and 100% disassemblable.

4 Tops are recessed and do not require any securing hardware.



4



Neil collection



Neil collection



Neil collection





Rock Table
 Rock Table Oval
 Rock Table Maxi

Rock Table collection

Designed by Jean Marie Massaud

EN Designed by Jean Marie Massaud, Rock Table is a 'round table' that seems to float above a solid, inorganic base. A refined, solid object, light and stable, radical and sensual, it is obtained through a mix of natural and industrial materials. The soft, iconic design based on essential shapes is combined with innovative production systems that make Rock Table suitable not only to living areas and modern living rooms, but also working areas such as offices and conference rooms, indoors and outdoors. Available in various sizes and finishes, even an oval variation, Rock Table opens a direct relationship among people sitting around the table, facilitating interaction and communication.

IT Disegnata da Jean Marie Massaud, Rock Table è una "tavola rotonda" che sembra levitare su una solida base inorganica. Un oggetto raffinato e solido, leggero e stabile, radicale e sensuale, è ottenuto grazie a una miscela di materiali naturali e industriali. Il design morbido e iconico, basato sulla semplificazione delle forme, si combina con sistemi di produzione innovativi che rendono i tavoli Rock adatti non solo ad aree living e soggiorni moderni ma anche a contesti lavorativi come uffici e sale riunioni, indoor e outdoor. Disponibile in diverse dimensioni e finiture, anche in una variante ovale, Rock Table consente un rapporto diretto tra chi siede attorno al tavolo, facilitando l'interazione e il dialogo.



Rock Table



Rock Table Maxi

1 Stone-chip cement finishes inspired by the colours of nature.

2 Rock Table round collection overview.



2

1



Achille collection





Neil collection



Neil Stool collection



3

3 Rock Table Mini, coffee tables in which the lines of the collection are repropotioned.

4 Rock Table Oval features two bases supporting an oval top.



5

5-6 Rock Table Maxi comes with a wooden top in three finishes, as well as in cement, stone-chip cement and lacquered versions.



4



6





Flow collection



S Table

Designed by Xavier Lust

EN A sound that reminds a shape, a name that speaks for itself: S Table, in which the liquid consonant perfectly tells about the twisted S-shaped stand of this table designed by Xavier Lust. The creations of award-winning designer actually stand out for the visible tension he gives to his objects, featuring curves inspired by the (de)formation process of metallic surfaces that identifies his whole creative path. The stand, moulded either in Ceramilux or in Cristalplant, technologically advanced, hypoallergenic and non-toxic material, can be crowned by different types of top – in crystal, in wood fiber, marble, in reconstructed stone or in Cristalplant – to further customise an already unique object. This design table's communication strength is remarkable, in any kind of space.

IT Un suono che evoca una forma, un nome che dice tutto: S Table, in cui la consonante liquida racconta perfettamente il basamento a S in torsione di questo tavolo progettato da Xavier Lust. D'altro canto, le creazioni del pluripremiato designer spiccano per la tensione visibile che conferisce ai suoi oggetti, con curve ispirate dal processo di (de)formazione delle superfici metalliche che identifica l'intero suo percorso creativo. Il basamento, stampato in Ceramilux o in Cristalplant, materiale tecnologicamente avanzato, ipoallergenico e atossico, può essere sormontato da differenti tipologie di top – in cristallo, in fibra di legno, in marmo, pietra ricostruita o ancora in Cristalplant – per conferire ulteriore personalizzazione a un oggetto di per sé, già unico. La forza comunicativa di questo tavolo di design è notevole, in qualsiasi genere di spazio.



1 Overview of the different S Table variants.



2



3

2 S table with marble table top finishes.

5



4

3 Marble Carrara matt/gloss white table top.

6

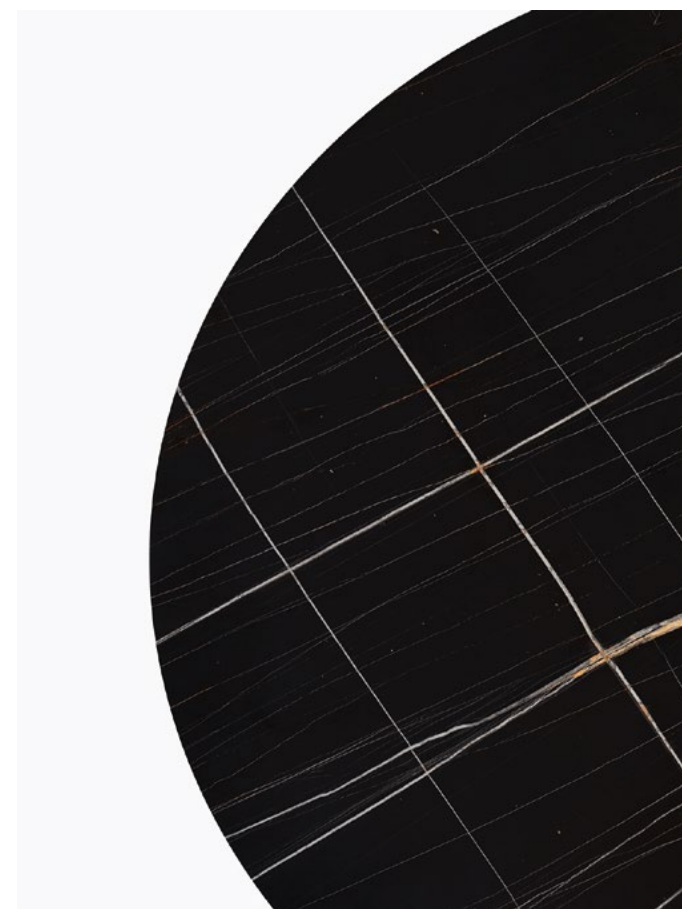

4 Marble Namibia matt/gloss white table top.

5-6 Marble Bardiglio matt/gloss medium grey table top and marble Sahara matt black table top.



Achille collection



1



2

5 heights, 16 finishes, 31 sizes,
1 thickness, over 1.200 combinations.

Tense
Tense Material

Tense collection

Designed by Piergiorgio & Michele Cazzaniga

En Designed in 2009 by Piergiorgio and Michele Cazzaniga, Tense represents the core idea of a table, so authentic and minimal that it adapts to the most varied environments, whether residential or professional. The extreme consistency of shapes and finishes, single, identical materials for the legs and top, transmits a feeling of lightness and stability, compactness and contemporary style. With a technological heart enclosed in the panel in the top, the table can reach up to 4 metres in length. Today, Tense is a system of tables defined through different materials, colours, and heights to meet any need.

It Progettata nel 2009 da Piergiorgio e Michele Cazzaniga, Tense rappresenta il nucleo dell'idea di tavolo, talmente autentico e minimale da adattarsi agli ambienti più svariati, sia residenziali che contract. La coerenza estrema di forme e finiture, monomateriche e identiche per gambe e top, veicola una sensazione di leggerezza e stabilità, compattezza e contemporaneità. Grazie a un cuore tecnologico, racchiuso nel pannello del piano, il tavolo può raggiungere sino a 4 metri di lunghezza. Oggi Tense è un sistema di tavoli che si articola in diversi materiali e colori e altezze, per rispondere a qualsiasi esigenza di utilizzo.



1-2 Tense in the monochromatic version, white resin or matt black and medium grey Fenix.

3 Tense represents the core idea of a table, so authentic and minimal that it adapts to the most varied environments.

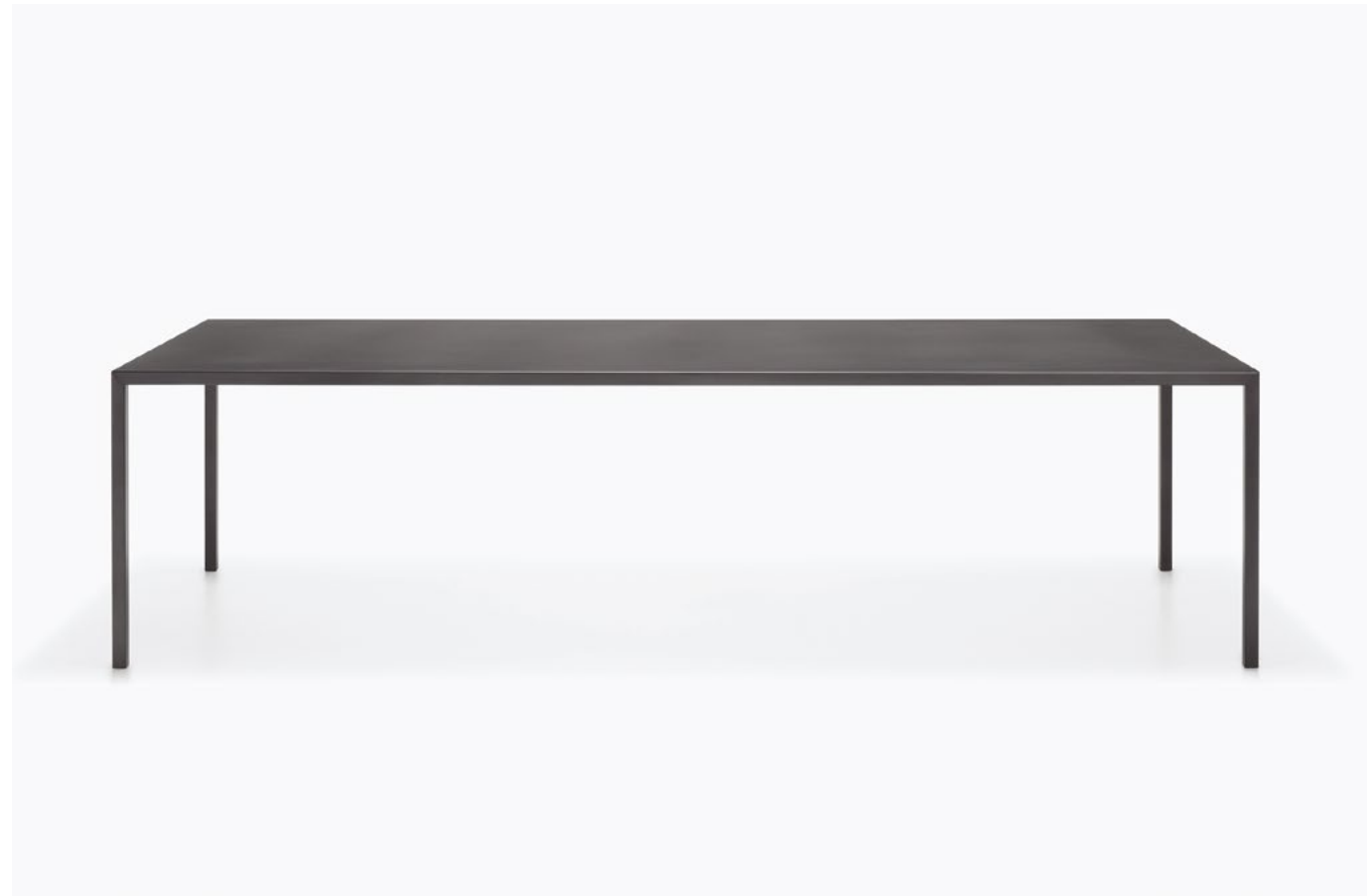

3



Flow collection

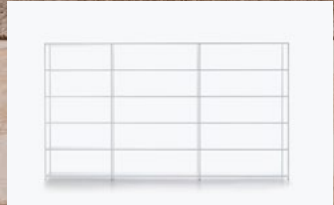

Minima collection



1

1 In the carbonised wood version, wood looks black with intense and fully natural shades.

2 Wood finishes overview: carbonised wood, Fine wood and natural oak wood.



3

3 Natural oak wood, top and legs coated by 3mm thick solid wood.

4 Fine wood: in Italian walnut, legs covered in 2 mm thick cut walnut, processed with sawed effect; top covered in 2 mm thick wood with fine smooth finish.



2



4

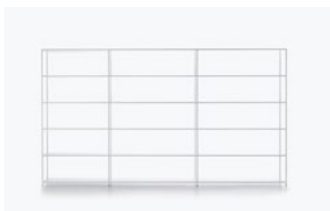

Minima collection



Universal collection



Aïku collection



Universal collection



1

1 The reconstructed stone finishes are obtained from mineral mixtures of marble and quartz.

2 The finishes are applied by hand over the entire surface of the table, creating unique shades.



3

3 The material essence of the finishes is enhanced by the essentiality and linearity of Tense.

4 Based on the lightness of their compositional balances, the new moods contrast elegantly with the fresh colours of reconstructed stone.



2



4



Neil collection



Flow collection



1

Tense Curve

Designed by Piergiorgio & Michele Cazzaniga

EN Tense, MDF Italia's elegant and versatile table, extends its already wide collection with a brand new proposal: Tense Curve, featuring a soft and sinuous silhouette. The Curve version originates from designers Piergiorgio and Michele Cazzaniga's will to undertake new formal researches, that enabled them to approach the round shape, that allows to increase the conviviality of guests, who can interact when they are sitting, with no sight restrictions. Tense Curve can be ideally placed in both dining rooms and living areas, and in working contexts, where oval-shaped tables are increasingly appreciated in meeting rooms.

IT Tense, l'elegante e versatile tavolo di MDF Italia, arricchisce la sua già ampia collezione con una nuova proposta: Tense Curve, dalla silhouette morbida e sinuosa. La versione Curve nasce dalla volontà dei progettisti Piergiorgio e Michele Cazzaniga d'intraprendere nuove ricerche formali, che hanno consentito di approdare alla forma tonda, la quale permette di aumentare la convivialità degli ospiti, che possono interagire quando sono seduti, senza avere limitazioni alla vista. Tense Curve trova la sua collocazione ideale sia nelle sale da pranzo e nei living di casa, sia in contesti lavorativi, dove i tavoli ovali vengono molto apprezzati nelle sale riunioni.



1 Tables available in the rectangular or square versions.

2 Tense Curve features a soft and sinuous silhouette.



2

20.Venti
20.Venti Light

20.Venti system

Designed by 967arch

En 20.Venti is an office system with a linear, iconic, versatile design created by 967arch. With a light structure, a contrast between full and empty, and quality materials and finishes, this is a contemporary interpretation of the desk, the archetypical workstation. Available in a wide range of sizes and colours, 20.Venti includes individual tables, double and quadruple workstations, a high workstation, and flexible combinations designed to adapt to spaces and the teams that use them. Combined with various accessories, 20.Venti allows to create a welcoming, functional space for working agilely and productively. In 2020, 20.Venti was selected for the 26th ADI Compasso d'Oro.

IT 20.Venti è un sistema per l'ufficio dal design lineare, iconico e versatile, disegnato da 976arch. Caratterizzato dalla struttura leggera, dalla contrapposizione tra pieni e vuoti e dalla qualità dei materiali e delle finiture, è una rivisitazione in chiave contemporanea dello scrittoio, archetipo della postazione di lavoro. Disponibile in un'ampia varietà di misure e varianti cromatiche, 20.Venti comprende tavoli singoli, postazioni doppie e quadruple, una workstation alta e alcune combinazioni flessibili, nate per adattarsi agli spazi e ai team di lavoro che le useranno. Abbinabile a diversi accessori, 20.Venti consente di creare uno spazio accogliente e funzionale in cui lavorare in modo agile e produttivo. Nel 2020, 20.Venti è stato selezionato per il XXVI Compasso d'Oro dell'ADI.



1



2

1 20.Venti includes individual tables, double and quadruple workstations.

2 With a light structure, a contrast between full and empty 20.Venti is a contemporary interpretation of the desk.

3-4 20.Venti includes a high workstation and flexible combinations.



5 Sound-absorption screen, panel with variable density internal padding patented by Snowsound

Technology, external polyester fabric cover Trevira CS.



3



4



5



M1



Divide IT



6



7

8

6-7 By adding accessories it is possible to enrich the workstation and organize the space in the best possible way.

8 The workstation can be equipped with sound-absorbing panels, under-top trays and wireway sleeves.

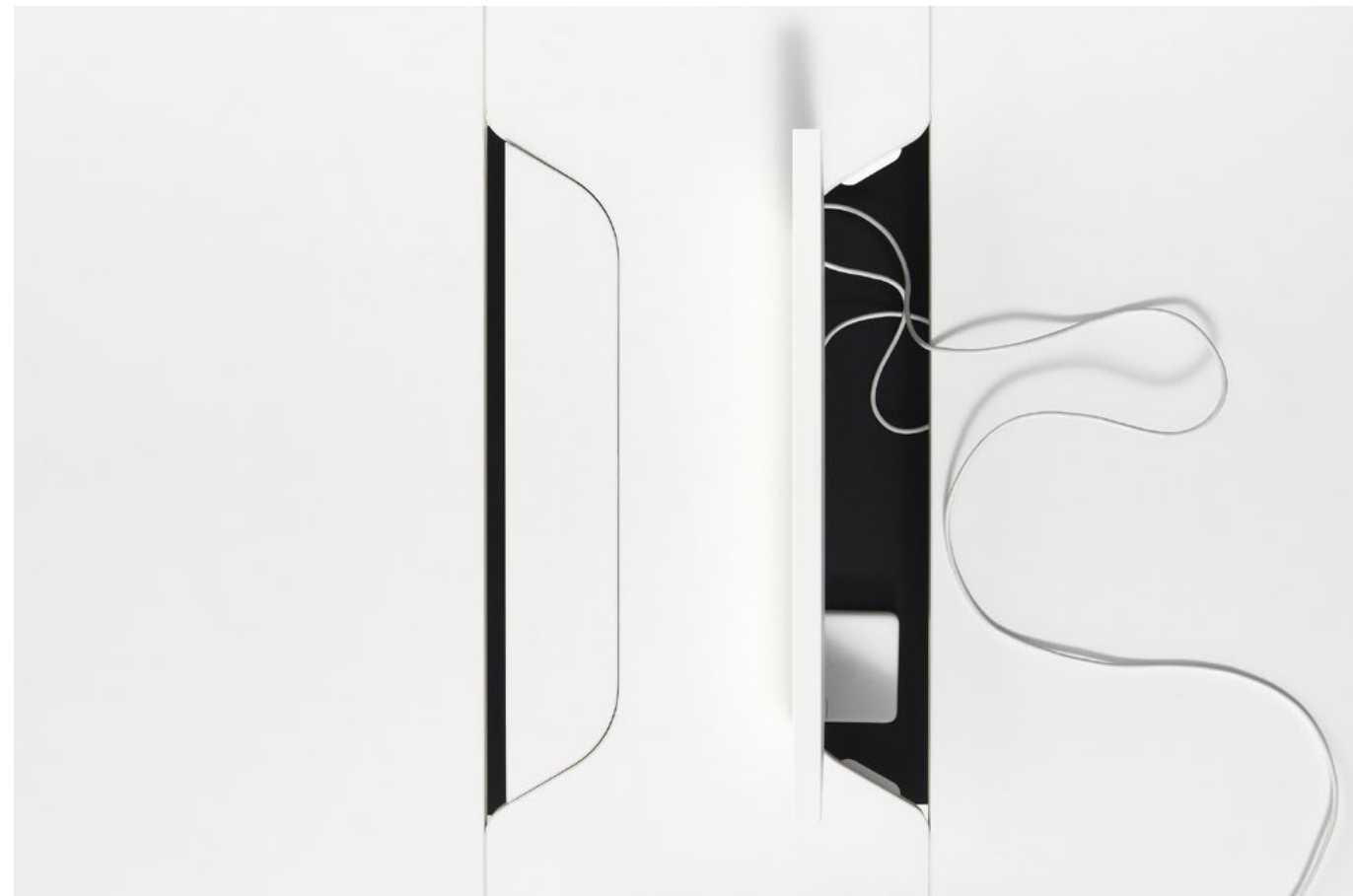

20.Venti Home
20.Venti Home Light

20.Venti Home

Designed by 967arch



1

1 Steel frame and legs and three wooden top finishes.

2 The home working desk is equipped with an aluminum opening for cable management.



2



+

3 The home working desk has a small drawer that can be accessed through a flap door and a functional cloth bag.



3



Achille collection





Arpa Low Table

Designed by Ramón Esteve Estudio

EN Arpa Low Table is a coffee table that plays on the geometry of shapes and the contrast between materials: the orthogonal stainless-steel structure accommodates ceramic material tops. Available in one size and several finishes, it is extremely versatile in integrating the indoor or outdoor living area.

IT Arpa Low Table è un tavolino che gioca sulla geometria delle forme e il contrasto tra i materiali: la struttura ortogonale in acciaio inox accoglie infatti top materici in ceramica. Disponibile in un'unica dimensione e in diverse finiture, si adatta con estrema versatilità a integrare la zona living indoor oppure outdoor.



1 Load-bearing structure in stainless steel, 2 x 2 cm section.

2 A transversal low table for indoor and outdoor environments.



1



2



1

Cosy Low Table

Designed by Francesco Rota

EN Small architectural solutions with strictly rigorous lines, Cozy Low table 1 contrast with the soft volumes of the padded items to underscore his functional features for the living area. Cozy low table 1 produced in curved aluminium, thickness 6mm, matt painted with epoxy powders in the colours white or graphite grey.

IT Piccole architetture dalle linee rigorose, Cozy Low table 1 si pone in contrasto con i volumi morbidi degli imbottiti, a sottolineare la loro funzionalità per la zona living. Cozy low table 1 realizzato in alluminio curvato spessore 6 mm, verniciato opaco a polveri epossidiche nei colori bianco o grigio grafite.



1 Coffee table that contrasts with the soft volumes of the padded items.

2 Available in two matt painted finishes.



2



Flow Low Table

Designed by Jean Marie Massaud

EN Round coffee tables in three dimensions. Base with a central leg made of aluminium, lacquered in matt white or gloss black. Table tops in matt white Cristalplant®, or gloss black Ceramilux®. Cristalplant® is a unique highly advanced composite material made up of natural minerals, polyester and acrylic polymers; thus it is an inert hypoallergenic and non toxic material. Cristalplant® is 100% recyclable. Ceramilux® is a material composed of natural minerals and polyester resin. The gelcoat film coating the surface of the material is made of a highly resistant acrylate polyester.

IT Tavolini tondi in 3 dimensioni. Base a stelo in alluminio verniciato nei colori bianco opaco o nero lucido. Piano in Cristalplant® bianco opaco o Ceramilux® nero lucido. Cristalplant® è un materiale composito tecnologicamente avanzato ed unico, formato da cariche minerali naturali e polimeri poliesteri ed acrilici di elevata purezza; è quindi un materiale inerte, ipoallergenico e non tossico. Cristalplant® è riciclabile al 100%. Ceramilux® è un materiale composto da cariche minerali naturali e resina poliesteri. Il film di gelcoat che riveste la superficie del materiale è di tipo poliestere acrilato che consente di ottenere ottime caratteristiche di resistenza.



1 Round coffee tables in three dimensions and two colours.



1



Mia sofa



1

Fossil

Designed by Xavier Lust

EN The Belgian designer and sculptor is again joining forces with the brand, in an eclectic furnishing accessory that can be used as a low table. A highly versatile design for a family of elements, revisited with more rounded, fluid lines. Fossil is a sinuous element in three different sizes and heights. Suitable for both indoor and outdoor use. Its curved lines are in stark contrast with the white cement finish it is made of.

IT Il designer e scultore belga firma un piccolo complemento d'arredo di grande eclettismo, adatto ad assumere la funzione di tavolino basso e declinato in una famiglia di elementi accomunati da linee tondeggianti e fluide. Fossil è un elemento sinuoso proposto in tre diverse dimensioni e altezze. Si adatta sia per ambienti indoor che outdoor e le sue linee curve sono in netto contrasto con il cemento di cui è costituito. Realizzato in cemento alleggerito, veste una delicata finitura neutra colore bianco caldo che rievoca le nuance di un universo organico e naturale.



1 Fossil is a coffee table that works on the white concrete organic form and textural soul.

2 Three different dimensions to be used individually or in groups.



2



Cosy Island



La Table Basse

Designed by Xavier Lust

EN Low tables made with a curved natural aluminium sheet, in matt painted white and aluminium finishes. The design of the low table and the peculiarity of the bending in the aluminium sheet produce structural curvatures in the table top both in length and transversally. Such curvatures are a specific feature to the low table. Only 6 mm of sheet thickness.

IT Tavolino realizzato con lastra di alluminio curvata e piegata nelle seguenti finiture: verniciato alluminio e verniciato opaco bianco. Il disegno del tavolino e le particolari caratteristiche della piegatura della lastra realizzano curvature strutturali del piano sia longitudinalmente che trasversalmente. Tali curvature sono parte rilevante dell'identità del tavolino. Spessore della lastra di soli 6 mm.



1 La Table Basse is created using a 6-mm thick curved and painted aluminium sheet.



1



Metodo

Designed by Leonardo Talarico

EN A pure and rigorous design, featuring clear and precise, yet highly original lines: the brand new Metodo coffee table immediately catches the eye. Conceived according to a rigorous stylistic pattern, Metodo develops its shape in the space by means of circles that, placed on different levels, meet to create both the top and the entire structure. The result is a simple product, unforgettable and essential, with a strong personality. Metodo perfectly fits into many residential spaces: from the living area next to the sofas, up to the night area, as an ultra contemporary bedside table. With its silhouette, that from the first look is unmistakable, Metodo is an emotion, well defined in a living space.

IT Un design puro e rigoroso, dalle linee nette e precise, ma estremamente originali: cattura immediatamente l'attenzione l'inedito tavolino Metodo. Progettato seguendo uno schema stilistico rigoroso, Metodo sviluppa la sua forma nello spazio con cerchi che, posti su piani differenti, s'incontrano per creare sia il piano d'appoggio che l'intera struttura. Il risultato è un prodotto semplice, ma dal tratto identitario, essenziale, ma dalla forte personalità. Metodo si inserisce perfettamente in svariati ambienti residenziali: dal living, accanto ai divani sino alla zona notte, come comodino ultra contemporaneo.



1 Metodo features a 3mm thick steel structure, two heights and two diameters available.



1



Rock Table Mini

Designed by Jean Marie Massaud

EN The Rock Table family also includes the Mini Rock Tables: coffee tables with a strong personality, in which the lines of the collection are appropriately reproporioned to create furnishing accessories for the indoor or outdoor living space. These tables come with tops in three different heights and sizes, a trio useful for creating a wide range of compositions.

IT Dalla famiglia Rock Table nascono i Rock Table Mini: coffee table dalla forte personalità, in cui le linee della collezione sono opportunamente riproporzionate per realizzare complementi d'arredo a corredo del living indoor, oppure outdoor. I tavolini vengono proposti in tre differenti altezze e dimensioni di top, un trittico utile per creare svariate composizioni.



+

1 Low tables that come with tops in three different heights and sizes.

→ See the Rock Table collection Tables and Desks, p.164



1

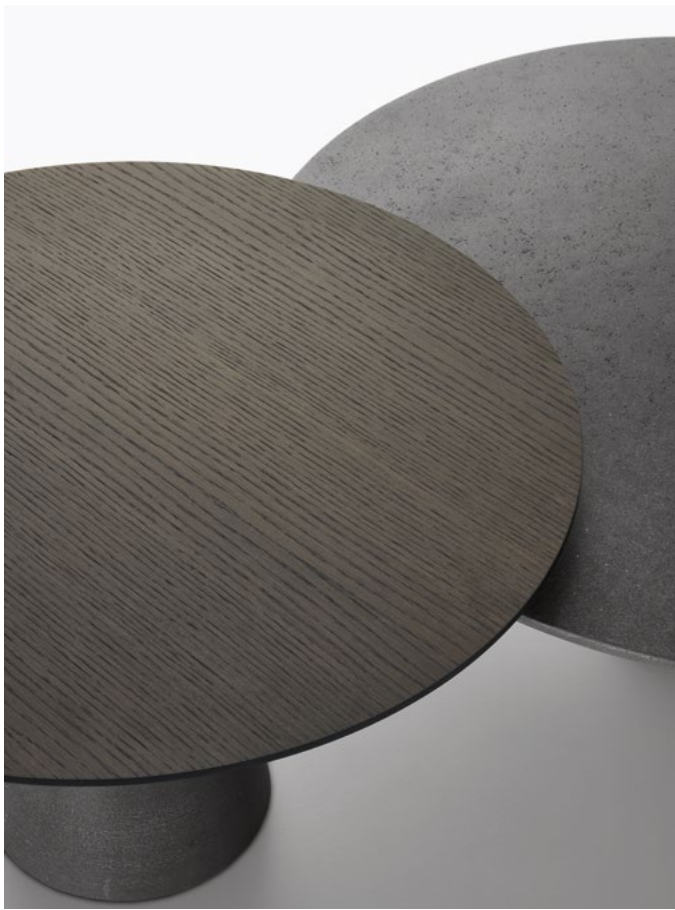

Tense Low Table

Designed by Piergiorgio & Michele Cazzaniga

EN Family of rectangular and square coffee tables made with the same materials and in the same finishes of the tables Tense, Tense Material and Tense Material Intarsia. Small, discreet, essential: Tense Low table combines practicality with a contemporary design, typical of the Tense family. Available in a wide range of dimensions and finishes from resin, to wood, stone and marble Tense Low table fits into both residential and contract contexts. Perfect in modern but also classic living rooms, it adapts to receptions, lounge areas and waiting rooms. Heights 45 / 35 cm.

IT Famiglia di tavolini rettangolari e quadrati, realizzati con gli stessi materiali e le medesime finiture dei tavoli Tense, Tense Material e Tense Material Intarsia. Piccoli, discreti, essenziali: i tavolini Tense coniugano praticità ad un design contemporaneo, tipico della famiglia Tense. Disponibili in un'ampia gamma di dimensioni e finiture dalla resina, al legno fino alla pietra e al marmo s'inseriscono sia in contesti residenziali che contract. Perfetti nei soggiorni moderni ma anche classici, si adattano a reception, lounge area e sale d'attesa. Altezza 45 / 35 cm.



1 Family of rectangular and square coffee tables made with the same materials and in the same finishes of the Tense and Tense Material collection.

→ See the Rock Table collection Tables and Desks, p.182





1



2

1 A collection of low tables in rectangular and square shape in two different heights.

2 The aluminium frame accommodates tops in different finishes and materials.

Yale Low Table

Designed by Jean Marie Massaud

EN Low coffee tables, in rectangular and square shape, featuring the same design of the Yale, Yale X and Yale Bed frame. Frame in extruded aluminium and legs in diecast aluminium, lacquered matt white, lead black. Top available in different finishes and materials.

IT Tavolini bassi, rettangolari e quadrati, che riprendono il disegno della struttura del divano Yale, Yale X e Yale Bed. Struttura in estruso di alluminio e gambe pressofuse in alluminio verniciato opaco nei colori bianco, bronzo e nero piombo. Piani disponibili in differenti finiture e materiali.



+

3 Yale Low Table collection overview.



3



Yale X sofa

Chairs

Achille Chair
Achille Armchair

Achille collection

Designed by Jean Marie Massaud

EN Top comfort thanks to the padding, combined with a considerable visual impact. Attention to details, formal elegance, light and essential lines: all of these features combine naturally and harmoniously in Achille Armchair, designed by Jean Marie Massaud, that is perfect for business and residential spaces. Subtraction, synthesis and lightweight: these armchairs also express at best the French designer's stylistic research, focusing on a full and enveloping comfort idea. Achille Chair and Armchair feature either a fabric or leather completely removable covering, offered in different variants and shades.

IT Un comfort estremo, garantito dall'imbottitura, che si accompagna a un notevole impatto visivo. Cura dei dettagli, eleganza formale, linee leggere ed essenziali: tutte queste caratteristiche si uniscono in modo naturale e armonioso nella poltroncina Achille, progettata da Jean Marie Massaud, perfetta per spazi lavorativi, contract e ambienti residenziali. Riduzione, sintesi e leggerezza: anche queste sedute esprimono al meglio la ricerca stilistica del designer francese, con particolare accento su un'idea di comodità piena e avvolgente. Achille Chair e Armchair presentano un rivestimento in tessuto o in pelle, completamente sfoderabile, proposto in diverse varianti e tonalità.



Achille
Chair



Achille
Armchair

1 Achille Armchair
in black color.

2 Achille collection
overview.







NVL Table



Rock Table collection

Aïku collection

Designed by Jean Marie Massaud

EN Aïku comes from the Japanese word "haiku", and it means a short poem generally composed of three verses. Wonderful poems that in a few words express remarkable meanings. Due to its incredible shortness, it requires a considerable synthesis of thought and image. The meaning and the sound of this word reveal the project's concept, to reconcile the paradoxes of uses and sensitiveness. Two-colour shell with double finish: gloss outside, in black and white colours and inside with matt saffiano effect. Padded shell completely covered with fabric or leather. Bases available: 4-legged round-shaped base, sled base, sled base with armrests, sled base with armrests and table, 4-legged tapered base and 4-legged base in solid oak (natural, bleached or brown finish). Versions with 4-legged round-shaped base, sled bases and 4-legged tapered base are stackable.

IT Aïku deriva dal termine giapponese "haiku" e indica un breve componimento poetico generalmente composto da tre versi. Splendide poesie che in poche parole racchiudono grandi significati, per l'estrema brevità richiede una grande sintesi di pensiero e d'immagine. Il significato e il suono di questa parola rivelano il concept del progetto, di conciliare i paradossi di usi e sensibilità. Scocca bicolore con duplice finitura: esterna lucida, nei colori bianco e nero, interna con texture effetto "saffiano" opaco. Scocca imbottita completamente rivestita con tessuto o pelle. Basamenti disponibili: 4 gambe tonde, slitta, slitta con braccioli, slitta con tavoletta, 4 gambe conifera e 4 gambe legno in massello di rovere (naturale, sbiancato e marrone). Le varianti a 4 gambe tonde, slitta e 4 gambe conifera, sono impilabili tra loro.



1-3 Aïku with 4-legged natural and brown oak base, two-colours shell.

2 Aïku collection overview.





3



4

4 Aiku Soft with sled base and armrests.



5

5 Aiku Soft with sled base, armrests and table.



Tense collection

Flow Chair
Flow Slim
Flow Leather
Flow Textile

Flow collection

Designed by Jean Marie Massaud

EN Developed in 2009 from an idea by Jean Marie Massaud, Flow Chair is a versatile, flexible chair that has evolved over time into a family of products capable of meeting every need and style. The curves and elegance of the profile create a perfect blend of comfort and ergonomics. With different bases and a wide range of finishes, Flow integrates into the most varied contexts without ever betraying its original character. In 2014, the Flow line was enriched with the Slim variation, a small armchair with sinuous lines and a contemporary character. Like the original chair, it fits in harmoniously with any environment.

IT Nata nel 2009 da un'idea di Jean Marie Massaud, Flow Chair è una seduta versatile e flessibile, che nel tempo si è evoluta in una famiglia di prodotti in grado di soddisfare ogni esigenza e stile. Le linee curve e l'eleganza del profilo si combinano in un'alchimia perfetta di comfort ed ergonomia. Grazie a diversi basamenti e un'ampia gamma di finiture, Flow si integra nei contesti più diversi, senza mai tradire il suo carattere originale. Nel 2014, la linea Flow si è arricchita della variante Slim, una poltroncina dalle linee sinuose e dal carattere contemporaneo, che come la seduta originale si integra armoniosamente in qualsiasi ambiente.

1 8 bases, 10 shells, 4 colours,
250 fabrics, more than 100.000
configurations.

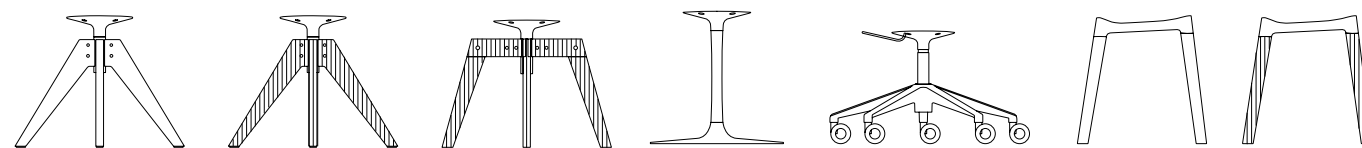
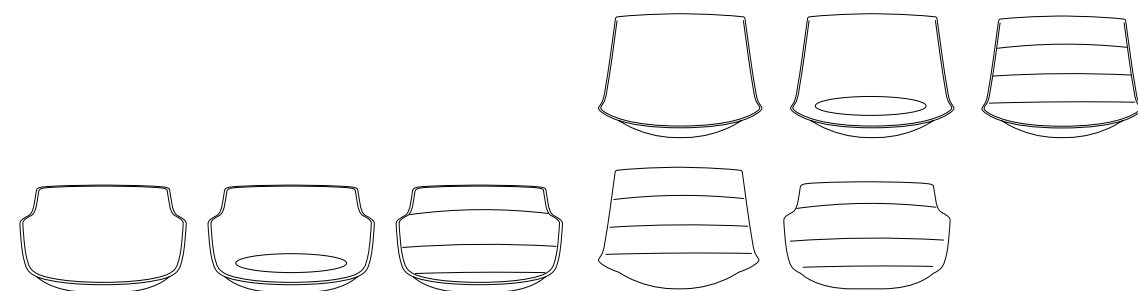
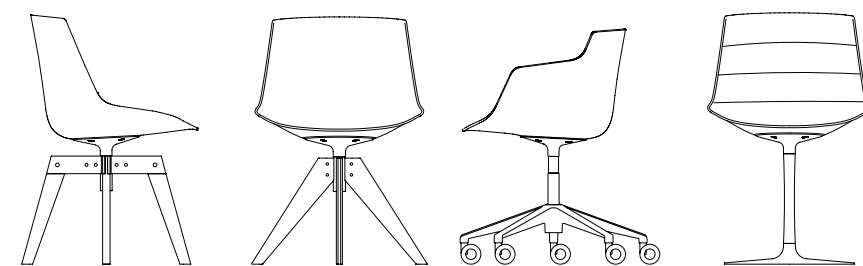

1



Flow Chair
Flow Chair padded

EN Flow Chair, far more than just a chair, this versatile and flexible product, with its constantly evolving design, has developed over time into a family of products that can satisfy any requirement or style. A curved seat and elegant profile blend in perfect harmony to ensure comfort and ergonomics alike. The Flow Chair shell can be enhanced by leather padding or in any of the over 200 fabrics in the MDF Italia collection, to increase its natural comfort and personality.

IT Flow Chair, non una semplice sedia, ma un prodotto versatile e flessibile; un progetto in continua evoluzione che nel tempo è diventato una famiglia di prodotto in grado di soddisfare ogni esigenza e stile. Le linee curve della seduta e l'eleganza del profilo si combinano in un'alchimia perfetta garantendo comfort ed ergonomia. Flow Chair può essere completata da un'imbottitura della contrococca in pelle, oppure negli oltre 200 tessuti della collezione MDF Italia, per aumentarne il naturale comfort e personalità.



1 4-legged oak base.

2 Height-adjustable 5-point-star base on castors, 360° swivel.



1



2



Rock Table collection



Flow Slim
Flow Slim padded

EN Flow Slim a sinuous armchair with a contemporary flair that blends perfectly with any environment, from the home to the office to public spaces. Like Flow Chair, Flow Slim can be personalised as to its base and shell, which can be enhanced by a classic padding (leather or in any of the over 200 MDF Italia fabrics), for increased comfort and support due to its shape.

IT Flow Slim una poltroncina dalle linee sinuose e dal carattere contemporaneo che si integra armoniosamente in qualsiasi ambiente, dalla casa, all'ufficio, agli spazi pubblici. Come Flow Chair, anche Flow Slim è personalizzabile nella scelta del basamento e della scocca, che può essere completata da un'imbottitura, in pelle o negli oltre 200 tessuti MDF Italia, rendendo più confortevole il sostegno dato dalla forma.



2 4-legged oak cross base.

1-3 VN 4-legged oak base.



1

2

3

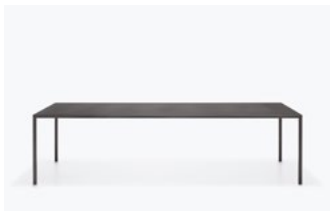

Tense collection



Flow Leather

EN This is how Flow Leather was born. Jean Marie Massaud's chair comes coated in two types of leather. The Anilina leather is offered in seven different colours. It is micro-perforated externally, while inside it is smooth. It is a premium leather, suitable for specific home environments such as dining rooms, living areas, but also for home office and smart working spaces. The Nuvola leather, conceived for business and public venues such as restaurants, hotels, offices, is a leather micro-perforated internally, while it is smooth on the outside: it is a contemporary, dynamic, high-impact covering, which at times recalls the look of sports car seats and comes in eleven colour tones.

IT La seduta di Jean Marie Massaud si propone rivestita in due tipologie di pelle. La pelle Anilina viene offerta in sette differenti tonalità, punzonata esternamente, mentre all'interno è liscia. Si tratta di una pelle premium, adatta a specifici ambienti domestici, come sale da pranzo, aree living, ma anche per gli spazi riservati all'home office e allo smart working. La pelle Nuvola invece, pensata per ambienti contract, come ristoranti, hotel, uffici, è una pelle punzonata internamente, mentre è liscia all'esterno: si tratta di un rivestimento contemporaneo, dinamico, di grande impatto, che a tratti ricorda il look dei sedili delle auto sportive e viene proposto in ben undici tonalità.



1 Flow Slim Leather with central leg and Anilina leather cover.

2 Flow Chair Leather with central leg and Anilina leather cover.

3 Flow Slim Leather 4-legged brown oak base, Nuvola leather.



1

2

3



4

4 Central leg base, Anilina leather.



5

5 Detail of the internal shell in smooth Anilina leather.

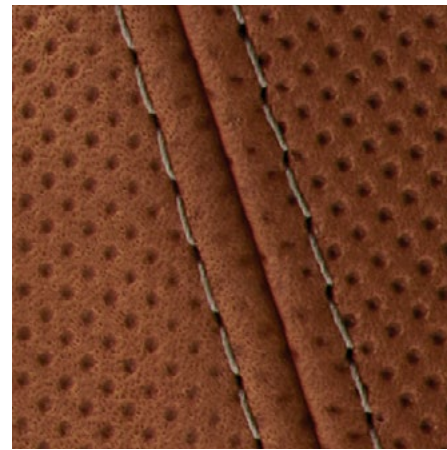

8

8 Detail of the micro-perforated leather.



9

9 Detail of the contrast stitching Anilina.

6 4-legged oak base, Nuvola leather.

7 VN 4-legged steel base, Nuvola leather.

10 4-legged oak base, Nuvola leather.

11 VN 4-legged steel base, Nuvola leather.



6

270

Flow collection



7

Chairs



10

271

MDF Italia



11

Indoor book



Tense collection



Flow Low Table



Flow Textile

EN Flow collection is presented in a padded and completely upholstered version with a wide range of bases and finishes. A version offering a refined upholstery work, to be naturally located in every soft business and residential space. Shell composed of a thermoformed and padded counter shell with a small pad made from quilted polyurethane and polyester wadding at the front. The textile part is made from removable fabric or leather, which can be supplemented with additional upholstery.

IT Flow Textile si conferma una nuova icona di stile, eleganza e comfort nella collezione Flow. Questa versione, dal raffinato lavoro di tappezzeria, troverà la sua naturale collocazione in tutti gli spazi soft contract o residenziali. Scocca composta da controscozza termoformata ed imbottita, con materassino di poliuretano e ovatta di poliestere trapuntati nella parte anteriore. La parte tessile è realizzata in tessuto o pelle, con possibilità di rivestimento supplementare.



1-3 Flow Slim a central leg base.

2 Flow Slim 4-legged oak base.



1

2

3





20. Venti Home



Flow Filo

Designed by Jean Marie Massaud

EN Flow: a timeless icon, Jean Marie Massaud created a brand-new variant of the famous chair in its two versions – chair and slim – in which research and craftsmanship are combined. With a steel core, the new chair is proposed with or without pad, available for both indoor and outdoor spaces. A single sled base completes the product. Perfect combination of design and manual flair, Flow Filo stands out for the precious craftsmanship of its processing, got by welding together the thin and shining steel wires which it is composed of. Like a precious artefact, the chair finds its ideal location in homes with both classic and contemporary style, also available in the outdoor version.

IT Flow: un'icona senza tempo, Jean Marie Massaud ha creato un'inedita variante della celebre seduta, sia in versione chair che slim, in cui si fondono ricerca ed artigianalità. Con un'anima d'acciaio, la nuova seduta viene proposta con o senza pad, disponibile sia per spazi indoor che outdoor. Un unico basamento a slitta completa il prodotto. Perfetto abbinamento tra design ed estro manuale, Flow Filo spicca per la preziosa artigianalità della sua lavorazione, ottenuta saldando insieme i sottili e splendidi fili d'acciaio di cui è composta. Come un prezioso manufatto, la seduta trova la sua ideale collocazione in abitazioni sia dallo stile classico che contemporaneo, anche nella versione outdoor.



1 Leather pad for indoor use.

2 Flow Filo collection overview.





Tense Capsule collection





1

M1

Designed by Piergiorgio Cazzaniga

EN MDF Italia pure and essential lines expressed in a practical, multitask slightly informal elegance. Piergiorgio Cazzaniga's M1 looks like this: an eco-friendly, fully recyclable chair, that is also stackable, in the plastic shell version, offering top functionality in every space. Available with plastic shell, either painted or coated with over 400 fabric or leather colour variations, M1 comes with the classic stainless steel or chrome base, and more recently, with a tone-on-tone painted base.

IT Le linee pure ed essenziali di MDF Italia declinate in un'eleganza pratica, multifunzione, più informale. È questo il biglietto da visita di M1 di Piergiorgio Cazzaniga, una seduta green, completamente riciclabile. Ma anche impilabile nella versione con scocca in plastica, all'insegna della massima funzionalità in ogni spazio. Disponibile con scocca in plastica, verniciata o rivestita con più di 400 varianti colore tra tessuti e pelli, M1 si propone con il classico basamento in acciaio inox o cromato, al quale si è recentemente aggiunto il basamento verniciato ton-sur-ton.



1 M1 matt painted white.

2 M1 collection overview.



2



La Grande Table





Neil Leather
Neil Textile
Neil Twist

Neil collection

Designed by Jean Marie Massaud

EN Created in 2018, the Neil family of chairs designed by Jean Marie Massaud is a project undergoing continuous development, which is marked by its essential nature, versatility, and careful design. The wire structure marks a simple, light architecture, while the leather, cord, or fabric upholstery, combined with the wide colour range, give it character and allow it to adapt to different indoor and outdoor environments, both residential and professional, depending on the specific needs. Products in the Neil collection, which include chairs and stools, have a sustainable core. Made with high-quality materials and smart production systems, they limit waste, last over time, and can be easily disassembled and recycled at their end of life.

IT Nata nel 2018, la famiglia di sedute Neil disegnata da Jean Marie Massaud è un progetto in continuo sviluppo, che si distingue per essenzialità, versatilità e accuratezza di progettazione. La struttura in filo d'acciaio disegna un'architettura semplice e leggera, mentre il rivestimento in cuoio, corda o tessuto, unito all'ampia gamma cromatica, le dona carattere, permettendole di adattarsi a diversi ambienti, indoor e outdoor, residenziali e contract, a seconda delle esigenze. I prodotti della collezione Neil, che includono sedie e sgabelli, hanno un animo sostenibile: realizzati con materiali di qualità e sistemi di produzione intelligenti, limitano gli sprechi, durano nel tempo e a fine vita possono essere facilmente smontati e riciclati.



+

1 The Neil collection responds both to outdoor and indoor needs with elegance and lightness,

combining iconic design, essentiality and comfort.

2 Neil collection overview.



1

2



3



4



3 The fabric upholstery, coupled and simply stretched on the frame.



5

4-5 The structure is made in steel wire and available in a glossy galvanic finish in black chrome.



Tense collection



1

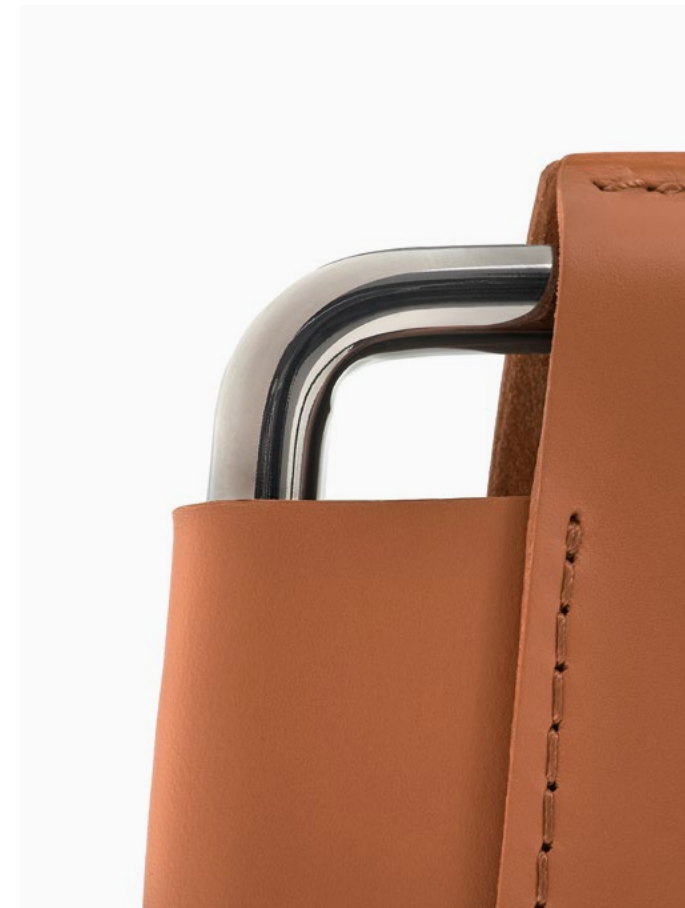

2



1-3 The thick full grain saddle-hide is simply.

2 The structure is made in steel wire and available in a glossy galvanic finish in black chrome.



3



Rock Table collection



Offset



1

1-3 Contrasting stitching detail, in anthracite colour.

2 Neil Twist chair overview.



2



3

Collaboration
with Jacob Cohën

Neil Denim

Designed by Jean Marie Massaud

EN From the meeting of the essential design of MDF Italia with the high tailoring of the luxury brand Jacob Cohën, Neil Denim is born, the new version in jeans of the iconic seat by Jean Marie Massaud. A chair that celebrates the constant search for materials and the innovative spirit that has always distinguished MDF Italia, this time in a denim finish. The two companies, in addition to being united by the use of high quality raw materials and Made in Italy production, have always been extremely attentive to the sustainability of the cycle of their products.

IT Dall'incontro del design essenziale di MDF Italia con l'alta sartorialità del luxury brand Jacob Cohën nasce Neil Denim, la nuova versione in jeans dell'iconica seduta di Jean Marie Massaud. Una sedia che celebra la costante ricerca dei materiali e lo spirito innovatore che da sempre contraddistingue MDF Italia, questa volta in finitura denim. Le due aziende, oltre ad essere accomunate dall'utilizzo di materie prime di elevata qualità e dalla produzione Made in Italy, sono da sempre estremamente attente alla sostenibilità del ciclo dei propri prodotti.



+

1 Upholstery in denim featuring top-stitched seams and contrasting tobacco

coloured detail stitching, inspired by classic jeans.

2 The frame is available in black chrome glossy galvanic finish or in matt black nickel.



1

2



Offset

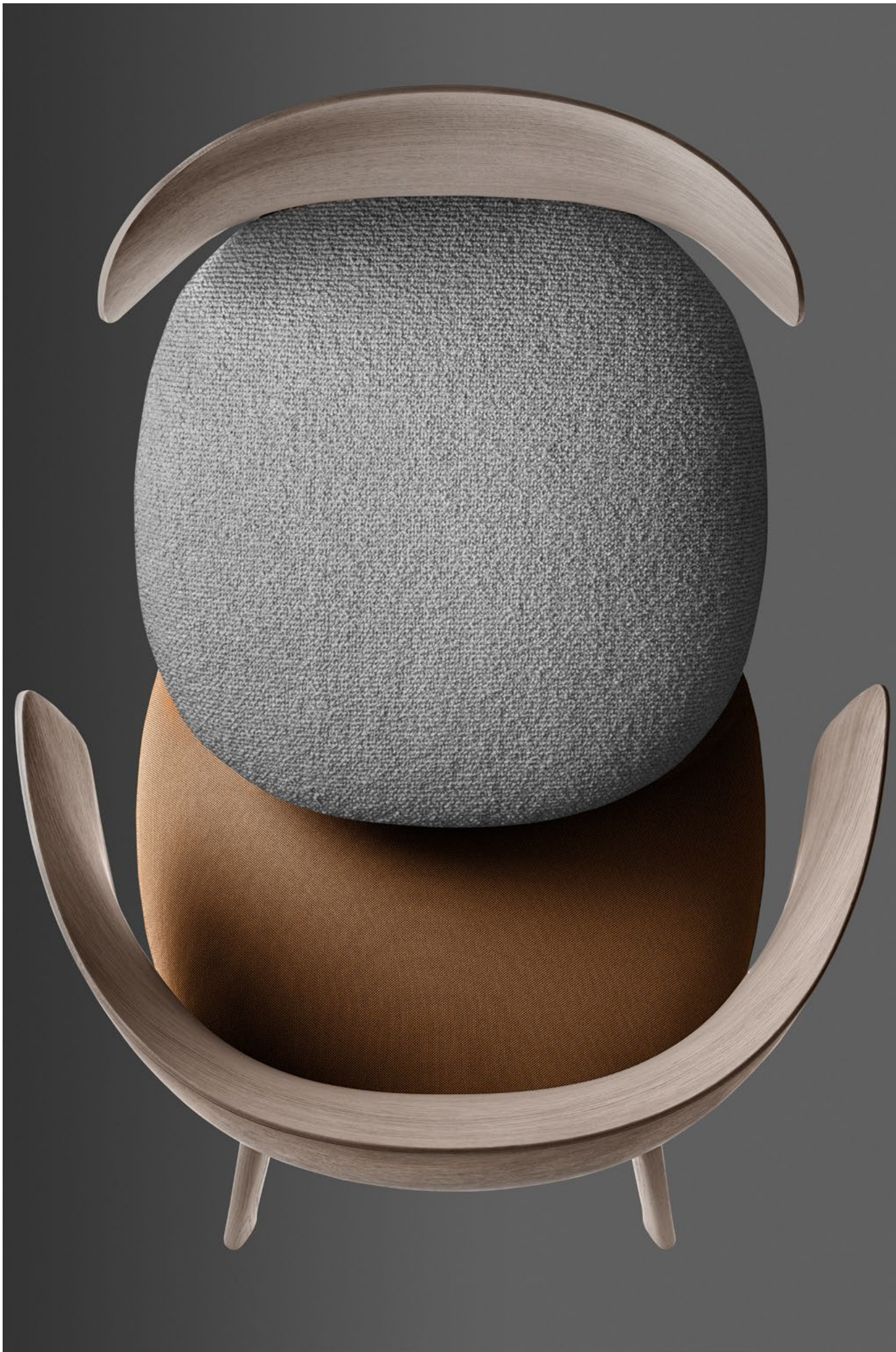

Universal chair
Universal armchair

Universal collection

Designed by Jean Marie Massaud

EN Universal is a family of chairs designed by Jean Marie Massaud that features a blend of elegant lines and excellent ergonomics. Based on patented wood-bending technology, Universal owes its name to the plate of the seat, the beating heart of the object. This is designed to support different types of bases or backrests, thus allowing for infinite configurations over time, due as well to the multiple textile combinations. The extreme versatility of the collection means it can be inserted in an original way in the most varied settings, from the home to professional contracts, in a classical or contemporary style.

IT Universal è la famiglia di sedute progettata da Jean Marie Massaud e caratterizzata dalla fusione tra linee eleganti ed ergonomia eccellente. Sviluppata a partire da una tecnologia brevettata sulla curvatura del legno, Universal deve il suo nome al piattello della seduta, cuore pulsante dell'oggetto, predisposto per accogliere diverse tipologie di basamenti e di schienali, permettendo così di sviluppare nel tempo infinite possibilità di configurazioni, grazie anche alle molteplici combinazioni tessili. L'estrema versatilità della collezione le consente di inserirsi in modo originale nei contesti più svariati, dal residenziale al contract, in ambienti dallo stile classico o contemporaneo.



1 Universal collection features impeccable elegance of line and extraordinary ergonomics.

2 In the chair and armchair with wooden backrest or fully upholstered, the three-dimensional back is the focal point of the seating.

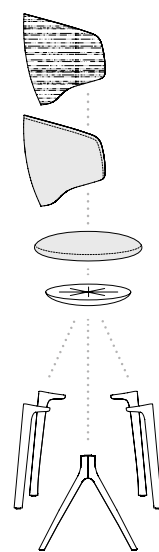

1

2



3



4

3-4 4-point-star base in die-cast aluminium with micro-embossed finish in white, graphite grey and shadow grey.

5-6 The concept was developed from a study on the curving of the wood which led to the

definition of an innovative, now patented production system.



5



6



7



8

7-8 4-legged oak base with structure in clear lacquered natural solid oak, available

in the two finishes brown oak and bleached oak.

9 Universal armchair padded.



9





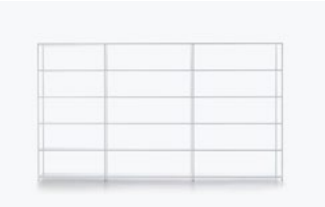

Minima



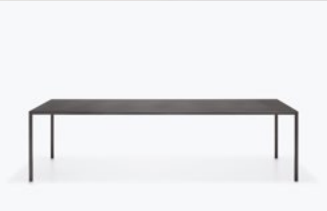

Tense collection



Aïku Stool
Aïku Soft Stool

Aïku Stool

Designed by Jean Marie Massaud

EN The Aïku chair collection, inspired to the short and romantic Japanese poems (haiku), extends and also includes stools. Aïku stool – elegant, convivial and smart – comes either with wooden base or with sled. The latter is stackable, which makes the stool highly performing, thus confirming its double aesthetic and functional nature. The shell is offered in all of the versions available for the chair, including the comfortable and wrapping padded model. Like the chair, Aïku stool was conceived for homes, restaurants – in particular, is recommended next to kitchen counters, bars and get-together areas – and collective spaces. In offices, Aïku stool is an ideal solution for the increasingly widespread habit of fast and standing meetings in 4.0 companies, in shared spaces, slightly less formal than meeting rooms.

IT La famiglia di sedute Aïku, ispirata ai brevi e romantici componimenti poetici giapponesi (haiku), si amplia, proponendo anche la versione stool. Lo sgabello Aïku, elegante, conviviale e cool, viene proposto con basamento in legno o con slitta. Quest'ultima versione è impilabile, il che rende lo stool straordinariamente performante, confermando la sua doppia natura, estetica e funzionale. La scocca viene proposta in tutte le opzioni disponibili per la seduta, inclusa la confortevole e avvolgente versione imbottita. Come la sedia, anche Aïku Stool è stato pensato per abitazioni, ristoranti – in particolare accanto a banconi di cucine, bar o aree conviviali – e spazi collettivi. Negli uffici è una soluzione ideale per le sempre più diffuse e veloci riunioni "in piedi" delle imprese 4.0, in spazi condivisi e un po' meno formali delle sale riunioni.



+

1 Two bases in two different heights, 64 cm and 76 cm.

2 Available with a two-tone or upholstered shell.



1

2





1

Flow Pouf

Designed by Jean Marie Massaud

EN Pouf designed for home, office and community areas, completing the Flow collection. Available with 4-legged oak base and VN 4-legged oak base. Upholstered with plywood frame covered with non-deformable polyurethane and polyester wadding, fully removable.

IT Pouf pensati per ambienti domestici, ufficio e comunità a completamento della collezione Flow. Disponibile con i basamenti 4 gambe rovere e 4 gambe rovere VN. Imbottitura in multistrato rivestito da poliuretano e ovatta e rivestimento sfoderabile.



1-2 Available with two bases in two finishes and over 200 fabric variants.



2



1

Flow Stool

Designed by Jean Marie Massaud

EN A family of stools of great impact and comfort completing the Flow Collection. Flow Stool with shell made from moulded polyurethane is in goffered matt white or black. The polyurethane used, called TECH®, is a high-density structural material that provides great resistance to impact, scratches and aging. Optional upholstered Pad. Flow Stool is available with sled base, VN 4-legged base in steel and 4-legged LEM base in white and graphite grey matt painted; VN 4-legged oak base in natural, bleached or brown finish.

IT Sgabelli di grande immagine e comfort a completamento della collezione Flow. Flow Stool con scocca in poliuretano, ottenuta per stampaggio, nei colori bianco e nero opaco con finitura goffrata. Il poliuretano utilizzato, denominato TECH®, è strutturale ad alta densità, garanzia di un'elevata resistenza agli urti, ai graffi e all'invecchiamento. Flow Stool è disponibile con i basamenti slitta, 4 gambe acciaio VN e 4 gambe LEM in verniciato bianco e grigio grafite opaco; 4 gambe rovere VN in rovere naturale, sbiancato e marrone. Pad imbottito opzionale.



+

1 Available with black or white shell in three different heights.

2-3 Available with sled base, VN 4-legged oak or steel base and LEM 4-legged-base.



2



3







Fuji pouf

Designed by Francesco Rota

EN Fuji is the new casual seating collection signed by Francesco Rota whose large, generous and sweet volumes and the trapezoidal silhouette evoke the conical shape of the Japanese volcano. A wide range of fabrics and colours easily merge these seats into every setting for casual and/or accessory seating. Polystyrene (PS) bearing frame, and multilayer base with concealed feet. Padding: variable-density foam polyurethane padding with polyester wadding. The fabric or leather covering every part of the pouf is manufactured to enhance its softness. In addition, the covers are completely removable.

IT Fuji è la nuova collezione di sedute informali a firma di Francesco Rota i cui volumi ampi e generosi e la silhouette dolce e trapezoidale ricordano la forma conica del vulcano giapponese. Vestiti da un'ampia gamma di tessuti e colori, lo rendono facilmente inseribile in qualunque contesto per una seduta occasionale e/o accessoria. Struttura portante realizzata in polistirene (PS) e basamento in multistrato con piedini nascosti. Imbottitura in poliuretano espanso a densità differenziata e ovatta di poliestere. Il rivestimento in tessuto o in pelle è confezionato in modo da esaltarne la morbidezza, ricopre il divano in ogni sua parte ed è completamente rimovibile.



1 Available in three different sizes and over 200 fabric options.

In addition to the monochrome version, the bicolor variant is available.



1



Neil Leather Stool
Neil Textile Stool
Neil Twist Stool

Neil Stool

Designed by Jean Marie Massaud

EN To complete Neil collection, Jean Marie Massaud also designed a stool version, creating a very versatile and complete family of seats. Available in two heights, 65cm and 78cm, the steel frame draws a linear silhouette in which the essential aesthetics is combined with comfort and ergonomics. Available in Leather, Textile and Twist version, Neil Stool confers an informal elegance to different environments and is perfect in combination with kitchens, bar counters and high tables. This product expresses its versatility not only in residential but also in contract settings, fitting effectively into various contemporary contexts. The different finishes available make Neil Stools perfect in various contexts with different styles.

IT A completamento della collezione Neil, Jean Marie Massaud ha pensato anche alla versione sgabello, dando vita ad una famiglia di sedute connotata da una grande versatilità. Disponibile in due altezze, 65cm e 78cm, la struttura in filo d'acciaio disegna una silhouette lineare in cui l'estetica essenziale non esclude comfort ed ergonomia della seduta. Disponibile nella versione leather, textile e twist, Neil stool connota con eleganza informale diversi ambienti ed è perfetto in abbinamento a cucine a isola, banconi bar e tavolini alti. Un prodotto che esprime la sua versatilità non solo in casa, ma anche in ambiti contract inserendosi efficacemente in diversi contesti contemporanei. Le diverse finiture a disposizione rendono gli sgabelli Neil adatti ad essere utilizzati in molteplici contesti connotati anche da stili diversi.



1 The steel load-bearing structure of the seat and backrest can be dressed in leather, rope or fabric.

2 Neil Stool, overview of the collection.

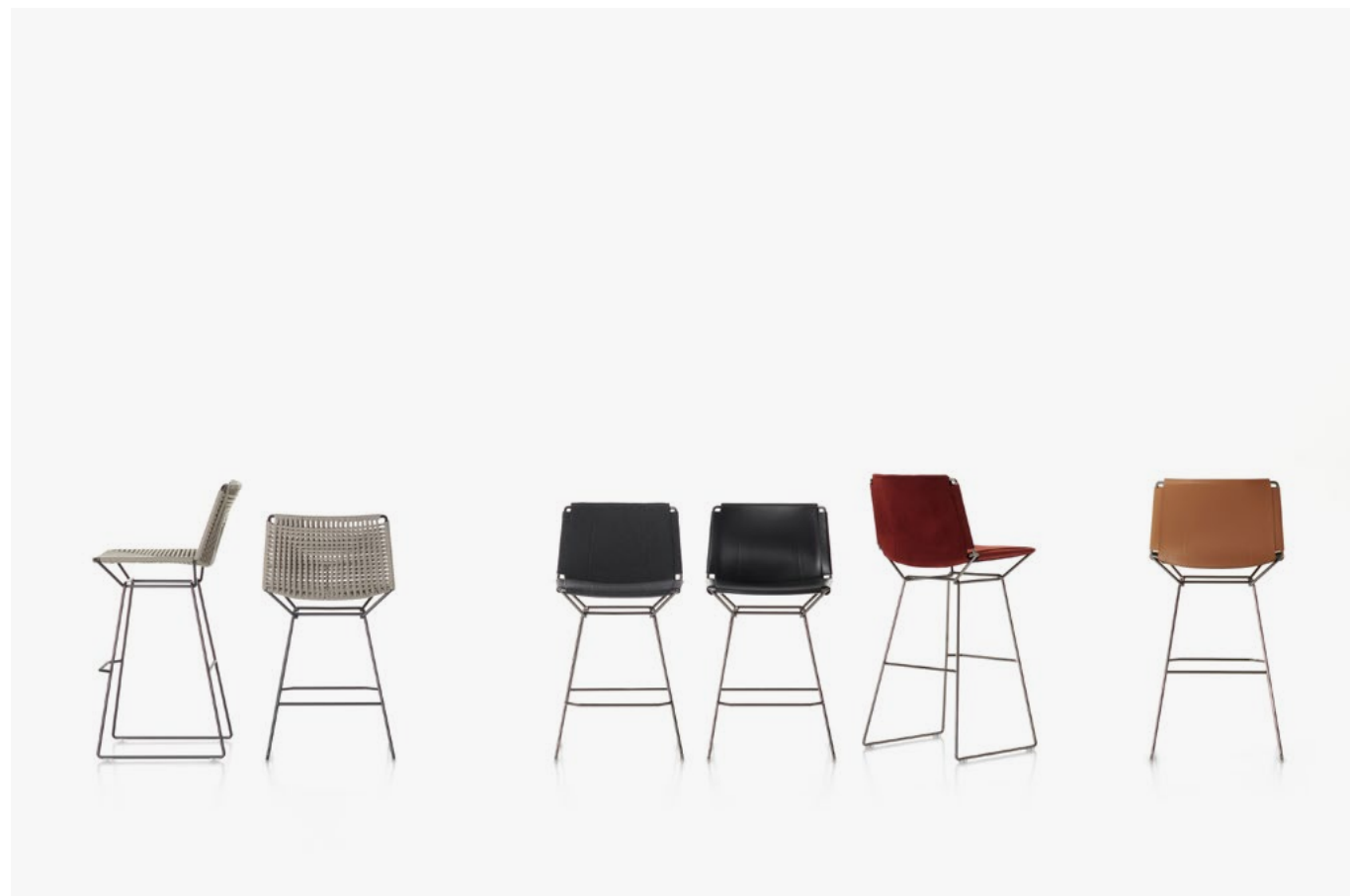



3



4

3-4 Available in two heights, 65 cm and 78 cm.

5 Neil Twist Stool, matt ecru cord weave.



5



Sag

Designed by Nendo

EN Either stool or table, outdoor or indoor: Sag represents a polyhedral and functional complement. Stool's legs are usually designed with "column" elements. On the contrary, Sag has been designed as a whole piece folded on itself, as a fabric suspended in the air and melted in three directions into a single shape. Its concave arc structure, thus generated, gives Sag its special soft and elastic image, but also an incredible sturdiness, capable of distributing forces and absorb loads.

IT Sgabello o tavolino, outdoor o indoor, Sag è un accessorio poliedrico e funzionale. Solitamente le gambe degli sgabelli sono elementi a "colonna", Sag al contrario, è stato concepito come un unico pezzo piegato su se stesso, come una stoffa sospesa nell'aria e fusa nelle tre direzioni in una singola forma. La struttura ad arco concavo, così generata, dona a Sag la sua peculiare immagine, morbida ed elastica, ma anche un'estrema robustezza, in grado di distribuire le forze ed assorbire i carichi. Sag è un progetto a tutto tondo, poiché anche l'imballo è stato oggetto di studio per l'usabilità, i materiali e l'innovazione. La variante in legno è composta da pannello in multistrato impiallacciato bambù, a doga stretta e con finitura evaporata. La sola variante con struttura e sedile in poliuretano, è prevista anche per uso esterno.



1 Sag provides an original interpretation of the traditional stool with a dynamic and fluid shape.

2 Sag can be used as a small table or seat.



Beds

Aluminium Bed

Designed by Bruno Fattorini

EN The rigor of forms got through the lens of simplicity, accompanied by a great expressive strength: Bruno Fattorini's Aluminium Bed means all that. A bed made of aluminium, a lightweight and flexible material that gives a contemporary touch to this furnishing solution, which also comes in the romantic version with canopy, as well as 65 cm high headboard. The aluminum model is very cool as well as the painted versions glossy or matt in black, white and red, fit for modern and evolving night areas.

IT Rigore delle forme ottenuta attraverso la lente della semplicità, accompagnato da una grande forza espressiva: tutto questo è racchiuso nell'Aluminium Bed progettato da Bruno Fattorini. Un letto in alluminio, materiale leggero e flessibile, che conferisce notevole contemporaneità al complemento, il quale viene proposto anche nella romantica versione con sommier a baldacchino, oppure con testiera alta 65 cm. Molto attuale è la versione in alluminio oltre alle versioni in verniciato lucido o opaco nei colori nero, bianco e rosso, adatta a zone notte moderne e in evoluzione.



1 A bed made of aluminium which also comes in the version with canopy.

2 Available in anodised aluminium or matt and glossy painted variants.

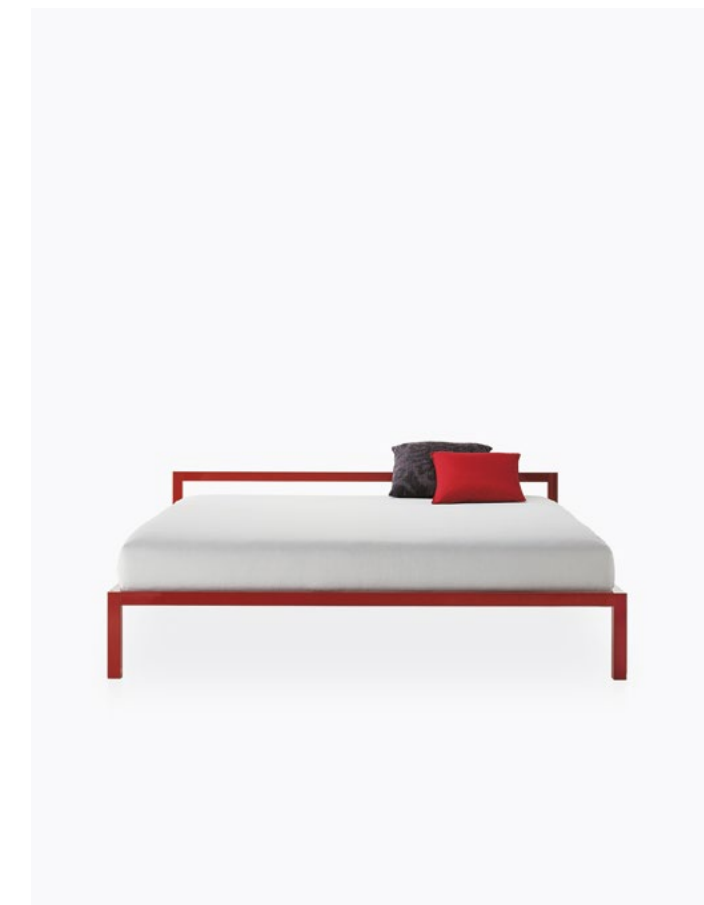

1

2



Flow Low Table

MDF Italia



Mia armchair

Indoor book

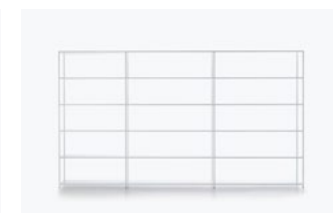

Minima collection



Flow Low Table



Yale Bed

Designed by Jean Marie Massaud

EN Jean Marie Massaud's latest creations were conceived for a functional and contemporary home, expressing a style and a way of living in which formal simplicity doesn't exclude creativity, quality, innovation and a sophisticated aesthetics. The designer extends Yale X's project idea to the night area, proposing again Yale's softness and comfort for the headboard, as well as the refined aesthetics of the sofa's stand as the hallmark of the bedframe. The bed is offered in two different versions – with low headboard H90 cm and with high headboard H103 cm – with fabrics or leather coating (completely removable), to meet different comfort needs and taste requirements. The contrasting seams characterise and identify the Yale Bed collection, only for the high headboard variant.

IT Le ultime creazioni di Jean Marie Massaud sono pensate per una casa funzionale e contemporanea, espressione di uno stile e di un modo di abitare in cui la semplicità formale non esclude creatività, qualità, innovazione ed un'estetica ricercata. Il designer declina l'idea progettuale del divano Yale X alla zona notte, riproponendo la morbidezza ed il comfort dell'imbottito per la testiera del letto e la raffinata estetica del basamento del divano quale elemento distintivo del giroletto. Yale Bed viene proposto in due versioni: a testata bassa H90 cm e a testata alta H103 cm con rivestimento in tessuto o pelle (completamente removibile) per soddisfare diverse esigenze di comfort e di stile. Caratterizza e identifica la collezione Yale Bed, nella sola variante a testata alta, la cucitura a contrasto.



1

1 Contrasting seams only on the high headboard.

2 The bed is offered in two different versions: with a low headboard H90 cm and with a high headboard H103 cm.



+

3 The aluminium frame is covered with a fabric or leather cover, which is completely removable.



2



3

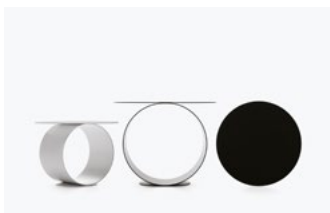

Metodo





1

Divide IT

Designed by Pitsou Kedem

EN Designed by the Israeli architect Pitsou Kedem, Divide IT, it is a dynamic product that adapts to every requirement and allows you to divide working spaces and home environments. At the same time, it maintains the sense of contiguity between adjacent rooms and creates suggestive and elegant perceptions. Divide IT is a furniture complement that moves easily and can change position at any time the user wishes. Available in two different sizes, it is composed of several panels which, rotating on an axis of 360 degrees, can be positioned to determine the passage of light and sound. This rotation allows for endless possibilities of partition, transition, and diffusion. A simple solution, still with strong identity: used individually or in combination with other dimensional and color variations, it allows you to create new spaces within environments without resorting to a fixed separation.

IT Progettato dall'architetto israeliano Pitsou Kedem, Divide IT, è un prodotto dinamico che si adatta ad ogni necessità e permette di dividere gli spazi di lavoro e dell'ambiente domestico, mantenendo però intatto il senso di contiguità tra stanze adiacenti e creare percezioni suggestive ed eleganti. Divide IT è un complemento che si sposta facilmente e può cambiare posizione in qualsiasi momento l'utente lo desidera. Disponibile in due diverse dimensioni, è composto da diversi pannelli che, ruotando su un asse di 360 gradi, possono essere posizionati per controllare il passaggio della luce e del suono. Questa rotazione consente di creare infinite possibilità di divisione, transizione e diffusione. Una soluzione semplice ma dai forti tratti identitari che, usata singolarmente o per accostamento con le altre varianti dimensionali e cromatiche, consente di creare nuovi spazi all'interno di ambienti senza ricorrere ad una separazione fissa.



1 Each divider element is available in two different sizes, L90 and L60 cm.

2 Divide IT can be arranged or placed to form attractive large-sized configurations.



2



3

3 The swivel panel can be rotated by 360°.

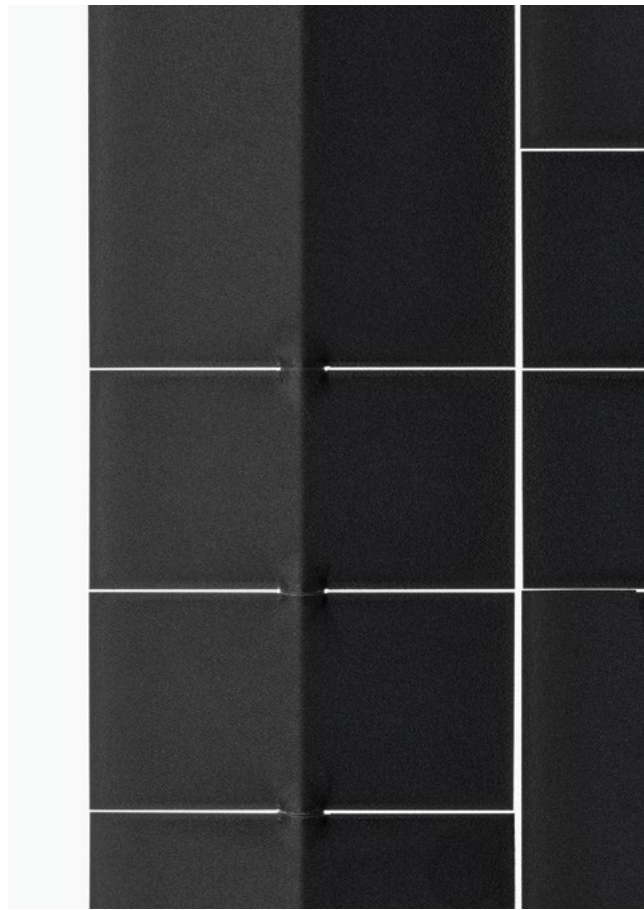

4

4 Divide IT in the sound-absorbing version limits the spread of sound waves in buildings and homes.



6

5-7 Divide IT allows work and home spaces to be divided in order to define unconstrained scenarios between work and living areas, between semi-private and public areas.



5

362

Divide IT

Complements

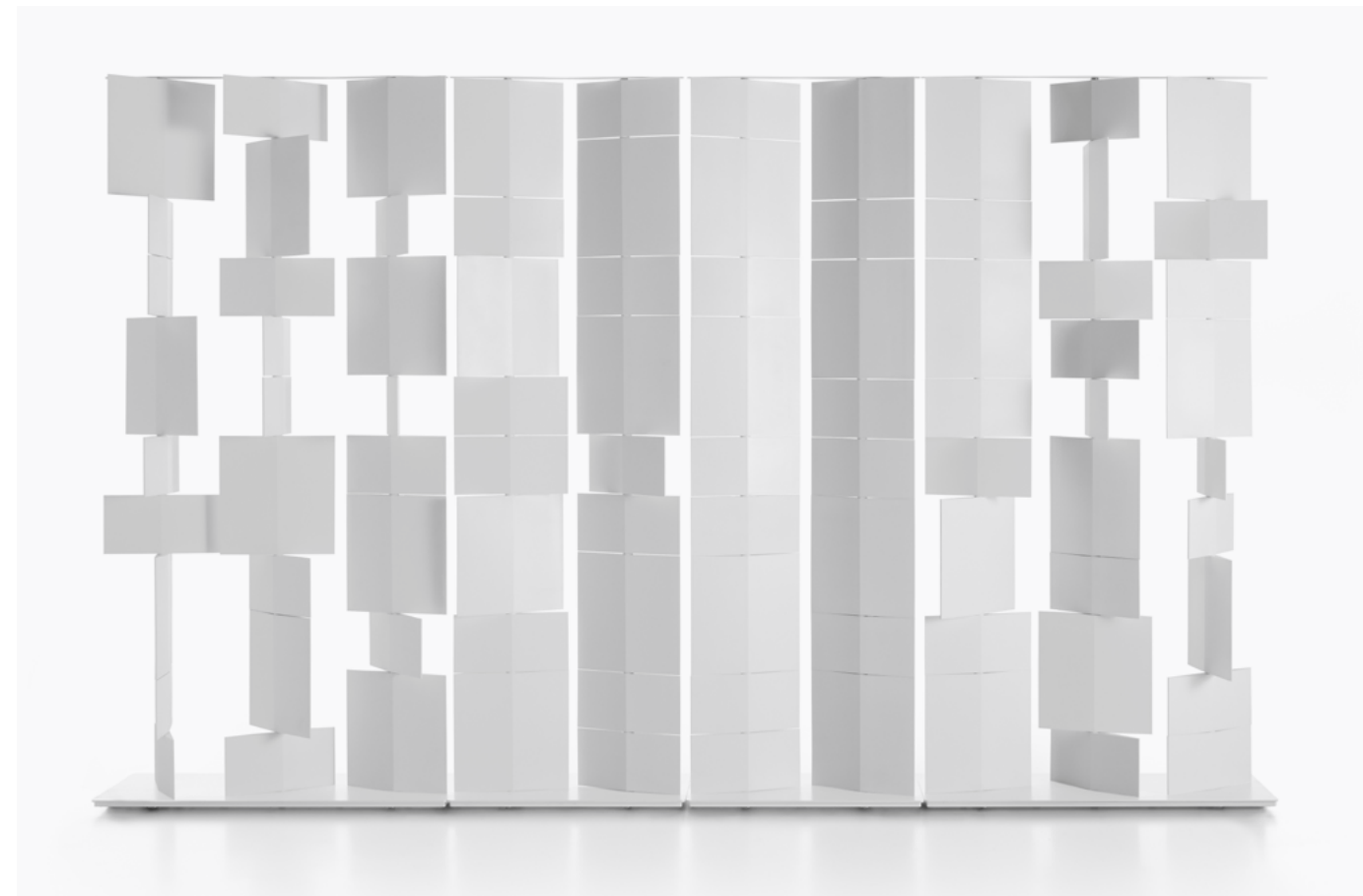

7

363

MDF Italia

Indoor book



Frammenti

Designed by Valentina Cameranesi & Enrico Pompili

EN The Frammenti collection, designed by the Cameranesi Pompili duo, is the perfect mix of creativity and craftsmanship. The result of an artisanal weaving technique, the collection is characterised by a design inspired by fragments of paper in different tones that compose a collage that plays on different shades of red or delicate neutral nuances, creating fascinating depth effects. A carpet with a contemporary spirit that recalls the traditional values of Nepalese weaving.

IT La collezione Frammenti, disegnata dal duo Cameranesi Pompili, è il perfetto mix tra creatività e lavorazione manuale. Risultato di una tecnica artigianale di tessitura, la collezione è caratterizzata da un disegno ispirato a frammenti di carta di diverse tonalità che compongono un collage che gioca sulle diverse sfumature del rosso o su delicate nuances neutre, creando affascinanti giochi di profondità. Un tappeto dallo spirito contemporaneo che richiama i valori tradizionali della tessitura nepalese.

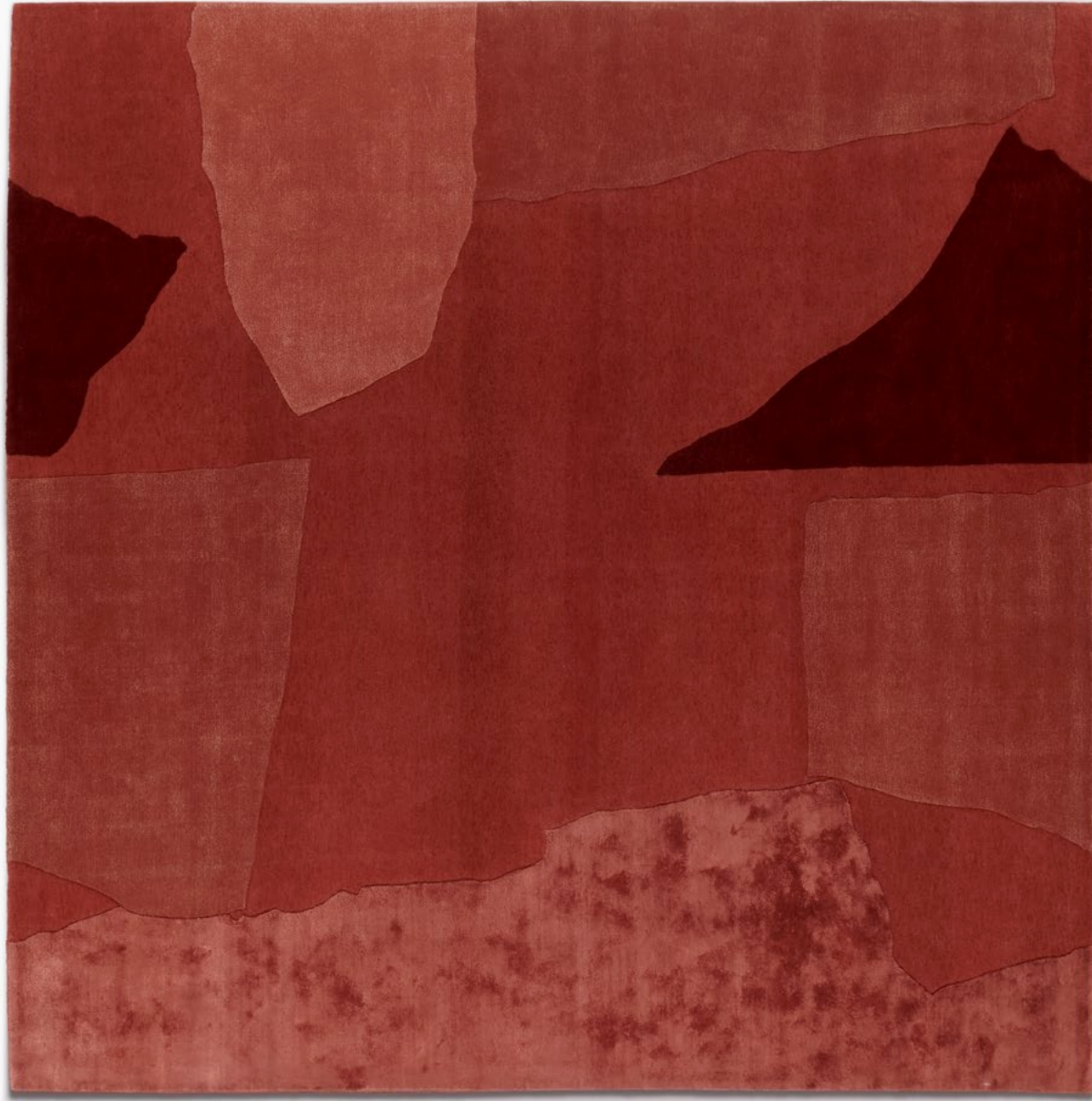

1-2 Hand-tufted carpets are the result of an artisan weaving technique that allows threads of wool or other material to be inserted.



Tatami

Designed by Valentina Cameranesi & Enrico Pompili

EN The Tatami collection, design by Valentina Cameranesi and Enrico Pompili, reinterprets the classic carpet in a contemporary key, suggesting an approach based on alternating Japanese-inspired graphics. Conceived in a neutral nuance, Tatami blends the essentiality of geometric shapes with refined elegance. Made in Nepal from wool and bamboo silk - an innovative yarn of natural origin - Tatami with its graphic signs fits perfectly into contemporary interiors.

IT La collezione Tatami, disegnata da Valentina Cameranesi ed Enrico Pompili, reinterpreta in chiave contemporanea il classico tappeto, suggerendo un approccio basato sull'alternanza grafica di ispirazione giapponese. Concepito in una nuance neutra, Tatami fonde l'essenzialità delle forme geometriche con raffinata eleganza. Realizzato in Nepal con filati in lana e seta di bambù - innovativo filato di origine naturale - Tatami con i suoi segni grafici si inserisce perfettamente negli interni contemporanei.



1 The Tatami carpets have simple geometric patterns, they are woven line by line on a horizontal loom.



1

Le Banc

Designed by Xavier Lust

EN An icon of lightweight and thinness, that fits easily in private residences, as well as in museums, public gardens, waiting rooms, community venues. Indoor and outdoor spaces, therefore for this bench with an aluminium soul, whose strong personality is due to the extraordinary flexibility of this material. A bench that sends a continuity and compactness feeling since it is composed either of a aluminium or white matt painted bent sheet, or gloss painted sheet in white, red or black (only 6 mm thick). With this creation, Xavier Lust harmoniously combined design, material and function, in a brilliant and original way.

IT Un'icona di leggerezza e sottigliezza, che s'inserisce disinvoltamente in residenze private, come in musei, giardini pubblici, sale d'attesa, luoghi della comunità. Spazi indoor e outdoor, dunque, per questa panca dall'anima in alluminio, la cui spiccata personalità è conferita proprio dalla straordinaria flessibilità di questo materiale. Una panca che veicola un senso di continuità e compattezza poiché formata da un'unica lamina curvata (spessore 6 mm) e verniciata opaca alluminio, bianco oppure verniciata lucida in bianco, rosso e nero. Con questa creazione, il designer Xavier Lust ha unito armoniosamente design, materiale e funzione, in modo brillante e originale.



1 Le Banc finishes overview.

2 Le Banc combines material and function in a sculptural product.



2





1

Link 1

Designed by Bruno Fattorini

EN Link 1 is associated with the evolution of current design concept, that goes beyond the traditional vision of pure aesthetic dimension, to be a polyhedral object in which function, simplicity, innovation and project culture are merged. A universal "line", useful for every need, conceived with a considerable capability of adapting to space. Link 1 shelf is available also in electrified version, with cable management door and back interspace to make cables pass and be hidden.

IT Link 1 si lega all'evoluzione del concetto più attuale di design, che oltrepassa la visione tradizionale della pura dimensione estetica, per essere un oggetto poliedrico in cui funzione, semplicità, innovazione e cultura di progetto convergono. Una 'linea' universale utile per ogni esigenza, concepita con una notevole capacità di adattarsi allo spazio. Link 1 mensola è disponibile anche in versione elettrificata, con antenna passacavi e intercapedine posteriore per il passaggio e il mascheramento dei cavi.



1 Link is a simple and pure sign capable of conversing with different shapes and of aggregating fairly with different products.

2 Shelf coated with natural oak wood.



2



Mamba
Mamba Light

Mamba collection

Designed by Victor Vasilev

EN A perfect synthesis of functionality and aesthetics, Mamba collection by Victor Vasilev fits perfectly into both the living and sleeping areas, responding to the requirements of the contemporary home office. A continuous line draws on the wall a shelf with sinuous and elegant shapes that can also be used as a desk. In the Light version, the dimensions are reduced and the colour range is expanded, making Mamba Light an extremely transversal complement to different environments and situations of use.

IT Perfetta sintesi tra funzionalità ed estetica, la collezione Mamba di Victor Vasilev si inserisce perfettamente sia nella zona living che in quella notte, rispondendo in modo efficace alle esigenze dell'home office contemporaneo. Una linea continua disegna sul muro una mensola dalle forme sinuose ed eleganti che può essere adibita anche a scrivania. Nella versione Light le dimensioni si riducono e la gamma cromatica si amplia, rendendo così Mamba Light un complemento estremamente trasversale a diversi ambienti e situazioni di utilizzo.



Mamba



Mamba Light

1 Form, function and material come together into an essential and functional design element

that can be used according to the needs as a desk or as a shelf.



2



3



4

3 Black ash finish.

2-4 Canaletto walnut finish.

5 Mamba Light, a hanging shelf-desk able to adapt to all spaces thanks to its essentiality.



5



1

1 Composition with decorative element in matt with Carrara marble.

2 Mirror Lines is a suggestive collection to enliven the home walls with new geometries and surprising effects.

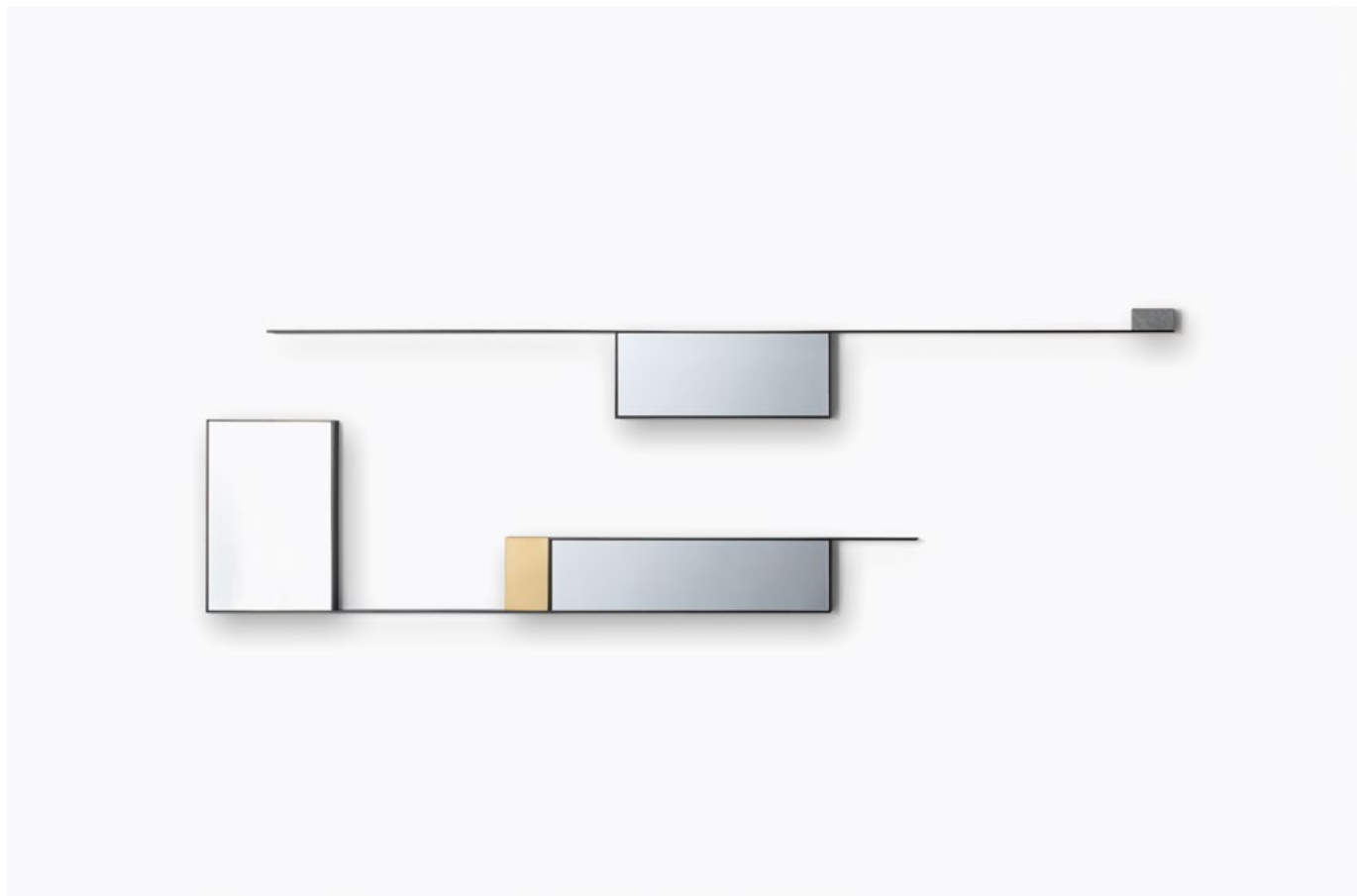

2

Mirror Lines

Designed by Irene Goldberg & Pitsou Kedem

EN An inspiration coming from the agricultural landscape, that at first surprised, then guided, the architects Irene Goldberg & Pitsou Kedem to develop Mirror Lines, the new MDF Italia collection of six mirrors. More precisely, the irrigated fields and the rice paddies seen from above led the architects to resume the geometric patterns of that world, projecting them into a creative line of mirrors. The glance is exciting: in the frame matt painted black nickel, next to the light reflected by the mirrors, decorative inserts in different materials stand out. A furnishing solution that irradiates vitality and energy, for an unusual, but original and highly involving overall view.

IT Un'ispirazione giunta dal paesaggio agricolo, che ha dapprima sorpreso, quindi guidato gli architetti Irene Goldberg & Pitsou Kedem a realizzare per MDF Italia la collezione di sei specchi Mirror Lines. Più precisamente sono stati i campi irrigati e le risaie visti dall'alto, che li hanno spinti a riprendere gli schemi geometrici di quel mondo e a proiettarli in una creativa linea di specchi. E il colpo d'occhio è emozionante: nella struttura in metallo verniciato nichel nero opaco accanto alla luce riflessa dagli specchi, si distinguono inserti decorativi in differenti materiali. Una soluzione d'arredo che veicola vitalità ed energia, per una veduta d'insieme inusuale, originale e altamente coinvolgente.



+

3 Horizontal compositions, length 155 cm, with decorative marble elements and black nickel structure.

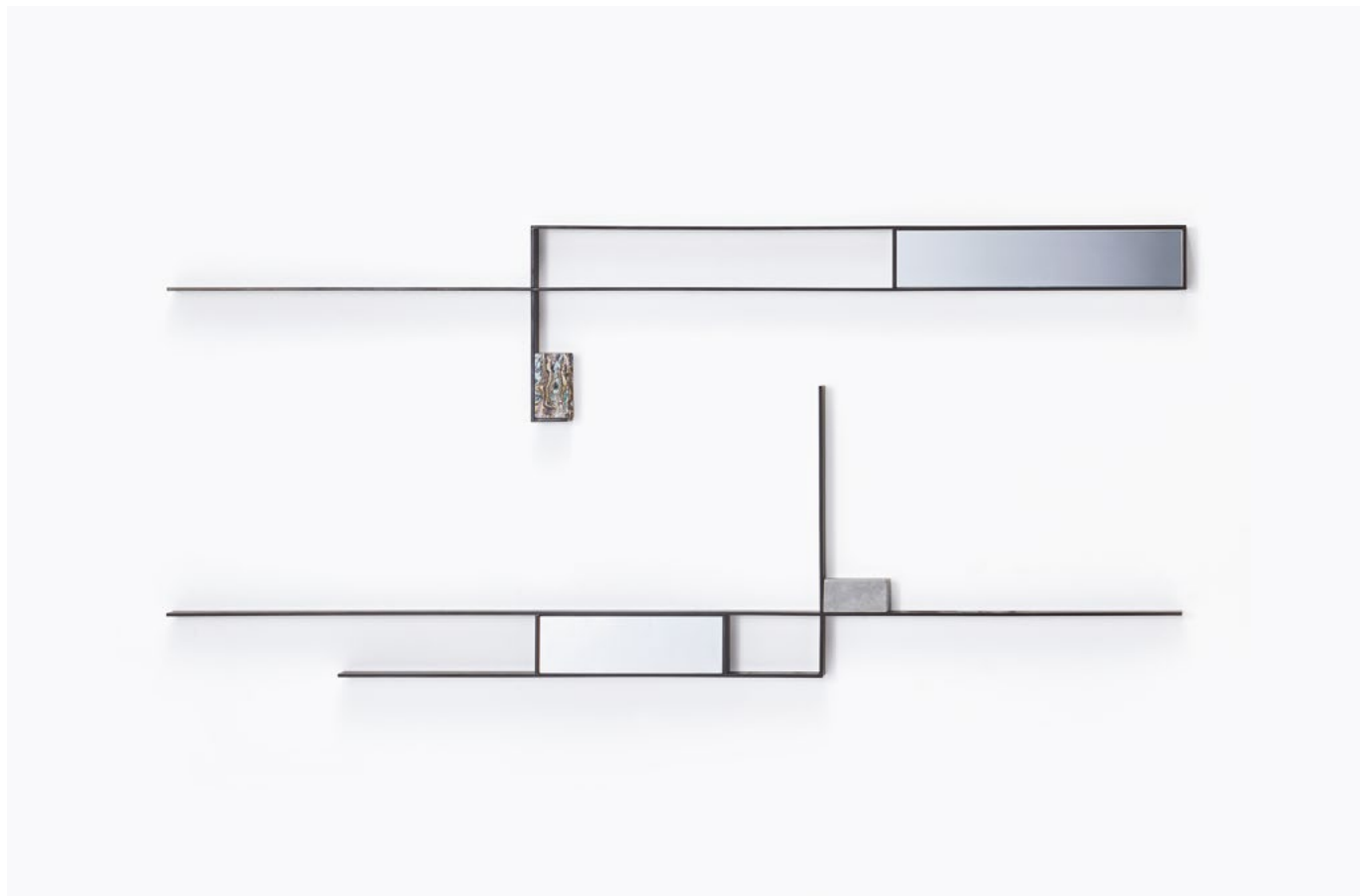

3



1



2

1 Office Cabinets and Office Cabinets Basic.

2 The office cabinets are complete of stationary tray.

Office Cabinets

Designed by Ufficio Tecnico MDF Italia

EN Office Cabinets is a drawer pedestal created in order to meet top quality and safety requirements in conformity with DIN and GS safety standards. Two types are available: three drawer chest of drawers with lock, complete with stationary drawer, with wheels and anti-tilt system; one drawer chest of drawer and one filing unit with lock, complete with stationary drawer, with wheels and anti-tilt system. Office Cabinets Basic instead, is certified EN, UNI e NF Enviroment. Available in the version with three drawer chest of drawers with lock, complete with stationary tray, with wheels and anti-tilt system.

IT Office Cabinets è la cassetiera creata per rispondere alle esigenze qualitative più elevate e alle normative DIN e GS in materia di sicurezza. Disponibile nelle due tipologie: cassetiera a tre cassetti con serratura, completa di cassetto porta cancelleria, con ruote e sistema di antiribaltamento; cassetiera a un cassetto e un classificatore con serratura, completa di cassetto porta cancelleria, con ruote e sistema di antiribaltamento. Office Cabinets Basic invece è certificata EN, UNI e NF Enviroment. Disponibile nella versione a tre cassetti con serratura, completa di accessorio porta cancelleria, con ruote e sistema antiribaltamento.



3 The cabinets are equipped with hidden and pirouetting wheels.



3



1

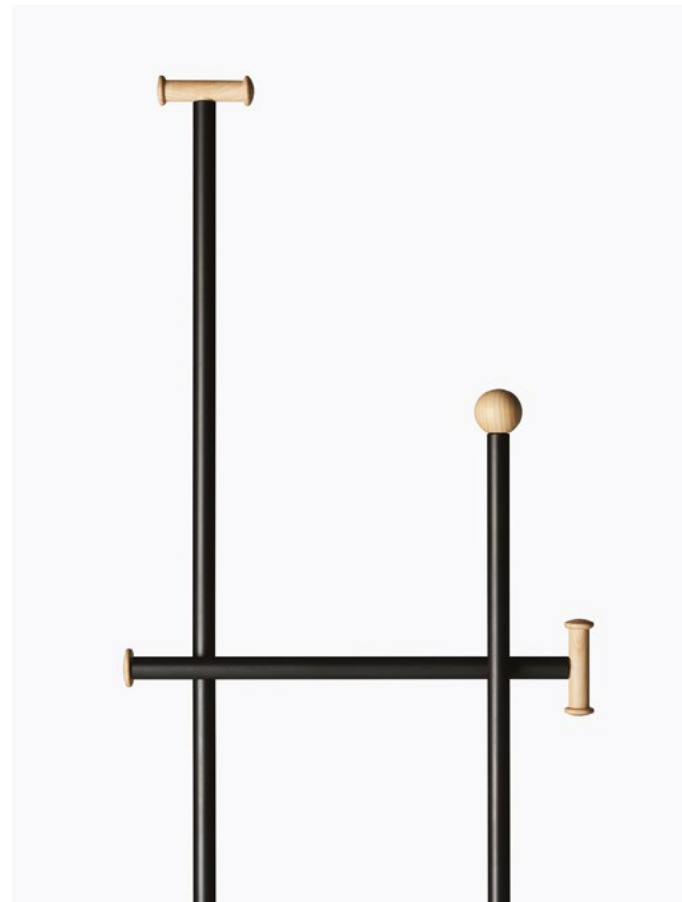

2

1 Clothes rack with walnut terminal pieces.

2 Clothes rack with walnut terminal pieces.



+

Ombre

Designed by Leonardo Talarico

EN Ombre, a plural name, indicates a single object created from simple lines. It is a tribute to essentiality, pure lines forming a functional complement, created for the living room, bedroom and office. A bended tube is crossed by linear tubing; this is how many passages are created for a clothing rack and a valet stand. The metal and wood inserts interact to make the structure remind of a sculpture, as well as to give form to a practical element. Both the clothes rack and the valet stand are equipped with terminal elements, in solid ash or walnut wood, that allow the clients creating endless solutions, depending on their own creativity. It is easy to change form and function, depending on personal needs and needs and mood of the moment.

IT Ombre, un nome plurale ad indicare un unico oggetto creato da semplici tratti. Un omaggio all'essenzialità, linee pure a favore di un complemento funzionale, pensato per il living, la zona notte e l'ufficio. Un tubo calandrato viene attraversato da un tubolare lineare; nascono così molteplici passaggi di un appendiabiti ed un servomuto. Il metallo e gli inserti in legno, dialogano assieme per rendere una struttura scultorea, oltre a definire un elemento pratico e comodo. Sia l'appendiabiti che il servomuto sono dotati di elementi terminali realizzati in legno massello di frassino o noce sono elementi che consentono di creare infinite soluzioni a libera interpretazione creativa del cliente. Con un semplice gesto è possibile modificarne forma e funzione, secondo le esigenze, gli umori e le necessità del momento.

3 Ombre collection overview.



3

30 years Capsule collection

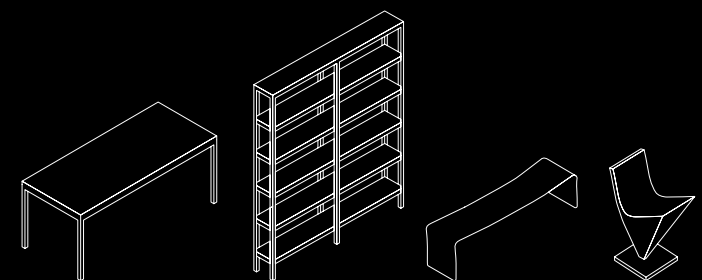

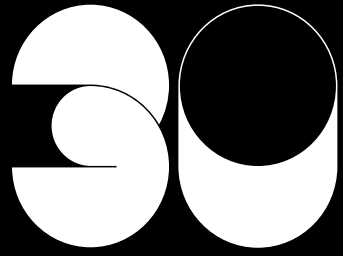

The Principle of Lightness



EN On the occasion of its 30th anniversary, MDF Italia launches a capsule collection which reimagines four classic products. The ambition of MDF Italia has always been to create design objects that not only satisfy the necessary requirements to become icons, but also succeed in establishing a set of universal principles that define the company's identity. Created to mark MDF Italia's 30th anniversary, The Principle of Lightness Collection –limited editions in hand polished steel or aluminium finishes –reimagines four exemplary products from its history; simultaneously freezing them in time and bringing new life to them.

IT In occasione del suo 30° anniversario, MDF Italia lancia una capsule collection che reinterpreta quattro prodotti iconici. Da sempre, l'ambizione di MDF Italia è creare oggetti di design che non solo abbiano la capacità di diventare icone, ma riescano nell'impresa di stabilire un canone, quell'insieme di principi universali che definisce l'identità di un'azienda. Realizzata in occasione dei trent'anni del brand, la collezione The Principle of Lightness è una capsule collection che ripropone quattro prodotti eccellenti della storia di MDF Italia - in edizione limitata, con finitura in acciaio o alluminio lucidati manualmente - congelandoli nel tempo e contemporaneamente offrendo loro una nuova vita.



Le Banc

Designed by Xavier Lust

EN Designed by Xavier Lust in 2001, Le Banc is a bench made from curved aluminium of just 6 mm thick. Thanks to its lightweight, slender and streamlined design, Le Banc is an icon that stands out making it suitable for public spaces and private residences, both indoors and outdoors. Today, as part of the MDF Italia collection, it is available in 3 finishes and 3 lengths. For The Principle of Lightness Collection, Le Banc has been reimagined in a hand polished aluminium finish and measures 170 cm in length.

IT Progettata da Xavier Lust nel 2001, Le Banc è una panca in alluminio curvato di soli 6 mm di spessore. Un'icona leggera e sottilissima, caratterizzata dalla continuità del segno, Le Banc è adatta a spazi pubblici e residenze private, indoor o outdoor. Oggi all'interno della collezione MDF Italia è disponibile in 3 finiture e 3 diverse lunghezze. Per la collezione The Principle of Lightness, Le Banc è riproposta con una finitura in alluminio lucidato manualmente, nelle dimensione 170 cm.

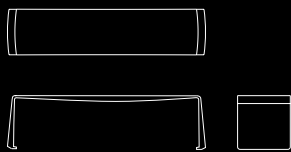

Lofty

Designed by Piergiorgio Cazzaniga

EN Designed by Piergiorgio Cazzaniga in 2004, the Lofty is a seating system in mirror polished stainless steel. As the perfect synthesis of technology and craftsmanship, the Lofty is the result of a laborious and lengthy process that entailed the study, design and shaping of steel into sophisticated, minimal geometrics. For The Principle of Lightness Collection, the Lofty has been reimagined as a chair in the original hand polished steel finish.

IT Disegnato da Piergiorgio Cazzaniga nel 2004, Lofty è un sistema di sedute in acciaio inox, lucidato a specchio. Una sintesi perfetta di tecnologia e manualità, Lofty è il risultato di un processo lungo e laborioso di studio, progettazione e modellazione dell'acciaio, che restituisce geometrie essenziali e sofisticate. Per la collezione The Principle of Lightness, Lofty è riproposta nella versione sedia, con la finitura originale in acciaio, lucidato manualmente.

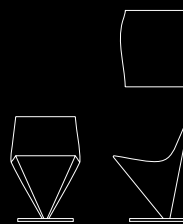

Minima

Designed by Bruno Fattorini

EN Having received the Honourable Mention at the 18th Compasso d'Oro ADI in 1998, the Minima is an aluminium bookcase system comprising three pivotal elements – shelves, frame, and cabinets– that can be freely configured. Designed by Bruno Fattorini and characterised by its minimalist and lightweight lines, the Minima is one of MDF Italia's most iconic products. For The Principle of Lightness Collection, the Minima has been reimagined in a hand polished aluminium finish and measures 184.5×188.5 cm.

IT Menzione d'onore XVIII Compasso d'Oro ADI nel 1998, Minima è un sistema di librerie in alluminio composto da tre elementi cardine –mensola, montante, contenitore – che possono essere configurati liberamente. Disegnata da Bruno Fattorini e caratterizzata dall'essenzialità e dalla leggerezza delle linee, Minima è uno dei prodotti icona di MDF Italia. Per la collezione The Principle of Lightness, Minima è riproposta con una finitura in alluminio lucidato a mano, composizione 184.5×188.5 cm.

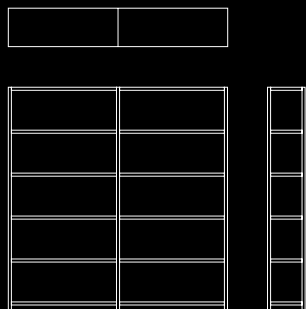

Tense

Designed by Piergiorgio e Michele Cazzaniga

EN Designed by Piergiorgio and Michele Cazzaniga in 2009, the Tense represents the archetypal table. Characterised by the consistency of its form and finishes, it is an icon of lightness and flexibility; thanks to its internal tension, it can also be extended to a total of 4 metres in length. Part of the MDF Italia collection, the Tense family is now available in 16 finishes, 5 heights and 36 sizes. For The Principle of Lightness Collection, the Tense has been reimagined in a hand polished aluminium finish and measures 100×240cm.

IT Progettato da Piergiorgio e Michele Cazzaniga nel 2009, Tense rappresenta l'archetipo dell'idea di tavolo. Caratterizzato dalla coerenza delle forme e delle finiture, è un'icona di leggerezza e flessibilità: grazie alla tensione interna, può raggiungere fino a 4 metri di lunghezza. All'interno delle collezioni MDF Italia, la famiglia Tense oggi è disponibile in 16 finiture, 5 altezze e 36 dimensioni. Per la collezione The Principle of Lightness, Tense è riproposto con una finitura in alluminio lucidato manualmente, nella dimensione 100×240cm.

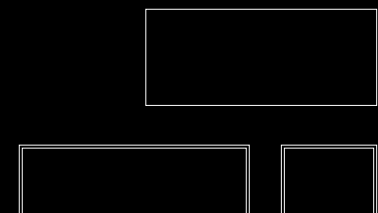

Credits

Graphic design
Studio CCRZ

Photo

Lorenzo Cappelini Baio
Simone Cavadini
Studio Controluce
Jonas Marguet
Thomas Pagani Nicolas
Polli
Amit Geron

Styling

Enrico Pompili
Valentina Cameranesi
Paola Pastorini Studio
con Simona Pozzi

Text

Communication & Marketing
MDF Italia
Ludovica Niero
Cosimo Bizzanti
Lisa Cadamuro

Thanks to

CC-Tapis
Flos
Golran
Midgard
Luceplan
Lumina

MDF Italia Srl Società Unipersonale

Headquarters

Via Fratelli Cervi 4/A
22066 Mariano Comense (CO)

© 2023

MDF Italia all rights reserved
MDF Italia reserves the right to change,
at any time and without prior warning,
the technical specifications of any products
illustrated in this catalogue.

www.mdfitalia.it



Discover the
Indoor products

M/920099-1299

Follow us



mdf italia

Communita^{MR}



Cuauhtémoc 158 B-I,
Col. Tizapán San Ángel
C.P. 01090, CDMX
Tels. 5512533780 / 5512533789
ventas@communita.com.mx
www.communita.com.mx

