

Snap 1100

SNAP COLLECTION:

Snap 1100, Snap 1100n, Snap 1101, Snap 1101n, Snap 1102, Snap 1102b, Snap 1103, Snap 1105, Snap 1105N, Snap 1106, Snap 1106N, Snap 1108, Snap 1109, Snap 1108N, Snap 1109N,

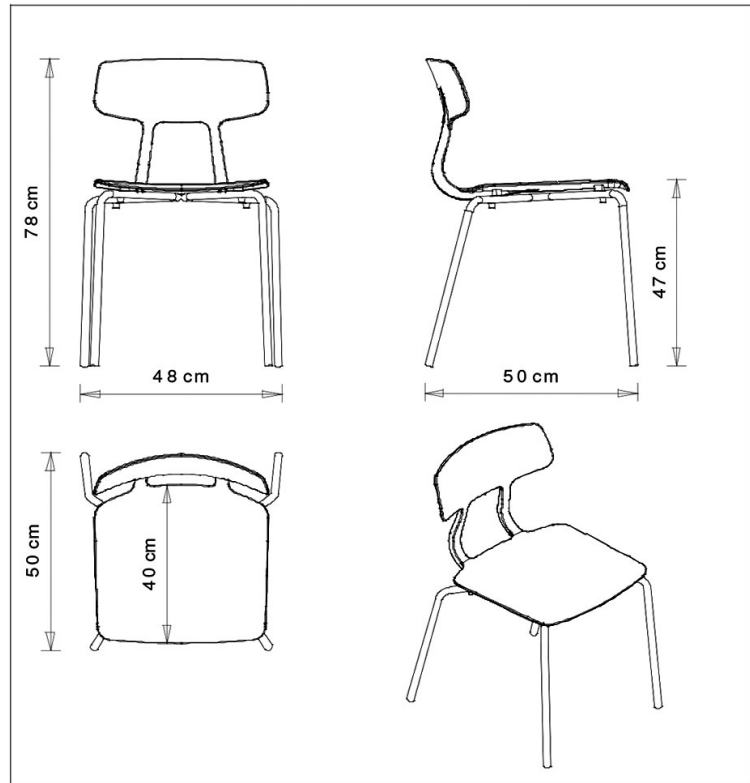

Chair with steel frame, 4 legs. Polypropylene shell.

[Watch the video](#)

STACKABLE

10

WEIGHT

4,1 kg

PACK

0,39 m³

PIECES PER BOX

4

FINISHES SEATING

PP POLYPROPYLENE

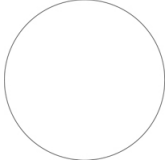

NCS S0502-B
Traffic white



NCS S 2005-G90Y
Hemp white



NCS S4005-B20G
Squirrel grey
(available while stocks last)



NCS S7502-B
Anthracite grey
(Available while stocks last)

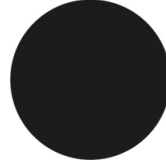

NCS S9000-N
Jet black

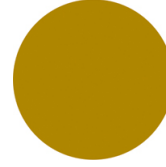

NCS S3060-Y Curry



NCS S4050-B40G
Water blue
(Available while stocks last)

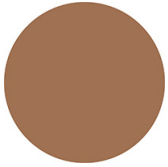

NCS S 5030-Y70R
Terracotta



NCS S4040-R
Marsala
(Available while stocks last)

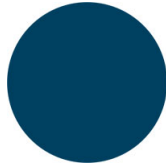

NCS S6030-B
Capri blue



NCS S7020-G50Y
Olive green



NOTE

Resources

BIM | 3ds | dwg

Notes

Shells in **olive green** and **marsala** are made of **100% recycled polypropylene** from industrial waste.

FRAMES

AC STEEL



NCS s0502-b VR Traffic
white
☀️



NCS S0500-N VR Pure
white
☀️



VR Pewter
☀️



NCS S4000-N VR
White aluminium
☀️



RAL 7016 Anthracite
grey
☀️



NCS S9000-N VR Jet
black
☀️



NCS S9000-N VR
Matt Jet Black
☀️



NCS S8005-Y20R
Brown
☀️



VR Rough metallic
bronze
☀️

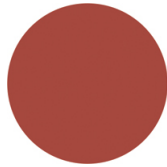

NCS S4040-R
Marsala
☀️



CR Chrome

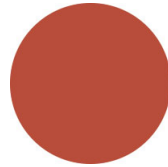

NCS S3060-Y80R
Coral red
☀️

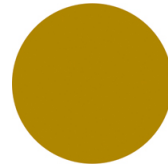

NCS S3060-Y Curry
☀️



NCS S7020-G50Y
Olive green
☀️



NCS S4050-B40G
Water blue
☀️

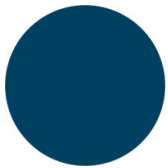

NCS S6030-B
Capri blue
☀️

USES

coffee & restaurants, entertainment, travel, office and waiting areas, outdoor,

Snap 1100n

SNAP COLLECTION:

Snap 1100, Snap 1100n, Snap 1101, Snap 1101n, Snap 1102, Snap 1102b, Snap 1103, Snap 1105, Snap 1105N, Snap 1106, Snap 1106N, Snap 1108, Snap 1109, Snap 1108N, Snap 1109N,

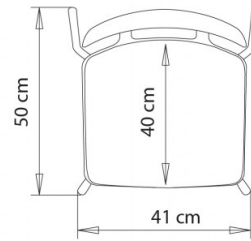
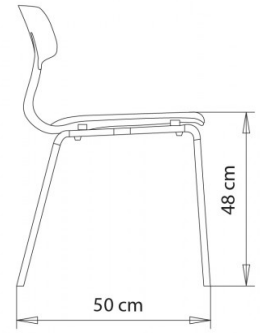
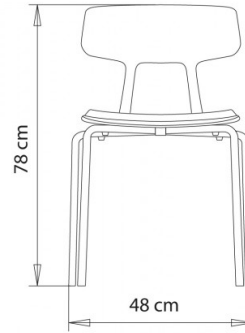

Chair with 4 legs steel frame. Upholstered seat.

WEIGHT

4,8 Kg

PACK

0,34 m³

PIECES PER BOX

1

FINISHES SEATING

PP POLYPROPYLENE

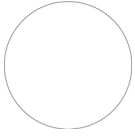

NCS S0502-B
Traffic white
☀️



NCS S 2005-G90Y
Hemp white
☀️



NCS S4005-B20G
Squirrel grey
(available while stocks last)
☀️



NCS S7502-B
Anthracite grey
(Available while stocks last)
☀️



NCS S9000-N
Jet black
☀️

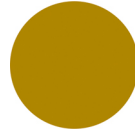

NCS S3060-Y Curry
☀️



NCS S4050-B40G
Water blue
(Available while stocks last)
☀️



NCS S 5030-Y70R
Terracotta
☀️



NCS S4040-R
Marsala
(Available while stocks last)
☀️

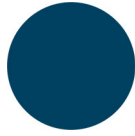

NCS S6030-B
Capri blue
☀️



NCS S7020-G50Y
Olive green
☀️

TE FABRICS

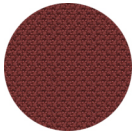

Alba
+ 8 colors



Aragon
+ 14 colors



Melva
+ 5 colors



Fortis + 8 colori



Roccia
+ 8 colors



Amsterdam
+ 8 colors

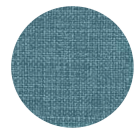

Medley Gabriel
+ 15 colors



Mirage
+ 8 colors

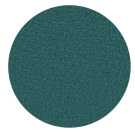

Inca
+ 14 colors

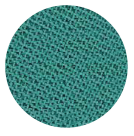

Chili Gabriel
+ 8 colors



Convert
+ 7 colors



Fenice
+ 8 colors



Mood Gabriel
+ 8 colors



Valencia
+ 14 colors

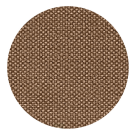

Reviva Hero
+ 10 colors
☀️



Fabthirty Rubelli
+ 8 colors
☀️

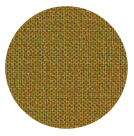

Remix 3 Kvadrat
+ 15 colors



Ocean Mastrotto
+ 15 colors

NOTE

Resources

3ds



dwg



Notes

Shells in **olive green** and **marsala** are made of **100% recycled polypropylene** from industrial waste.

FRAMES

AC STEEL



NCS s0502-b VR Traffic white
☀



NCS S0500-N VR Pure white
☀



VR Pewter
☀



NCS S4000-N VR White aluminium
☀



RAL 7016 Anthracite grey
☀



NCS S9000-N VR Jet black
☀



NCS S9000-N VR Matt Jet Black
☀



NCS S8005-Y20R Brown
☀



VR Rough metallic bronze
☀



NCS S4040-R Marsala
☀



CR Chrome

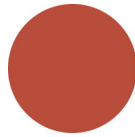

NCS S3060-Y80R Coral red
☀

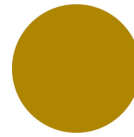

NCS S3060-Y Curry
☀



NCS S7020-G50Y Olive green
☀



NCS S4050-B40G Water blue
☀



NCS S6030-B Capri blue
☀

USES

coffee & restaurants, hotels, office and waiting areas, retail, Residenziale,

Snap 1101n

SNAP COLLECTION:

Snap 1100, Snap 1100n, Snap 1101, Snap 1101n, Snap 1102, Snap 1102b, Snap 1103, Snap 1105, Snap 1105N, Snap 1106, Snap 1106N, Snap 1108, Snap 1109, Snap 1108N, Snap 1109N,

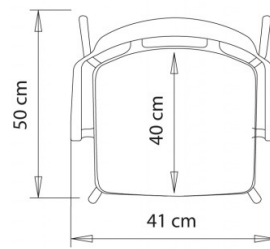
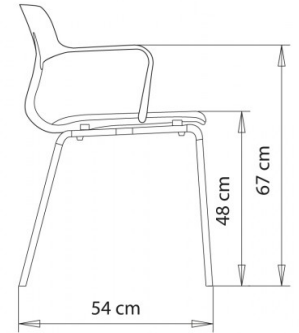
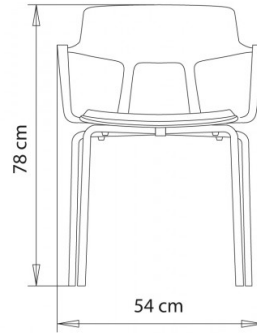

Chair with armrests and 4 legs steel frame. Upholsterd seat.

WEIGHT

5,1 Kg

PACK

0,34 m³

PIECES PER BOX

1

FINISHES SEATING

PP POLYPROPYLENE

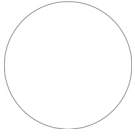

NCS S0502-B
Traffic white
☀️



NCS S 2005-G90Y
Hemp white
☀️



NCS S4005-B20G
Squirrel grey
(available while stocks last)
☀️



NCS S7502-B
Anthracite grey
(Available while stocks last)
☀️



NCS S9000-N
Jet black
☀️

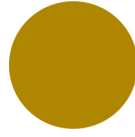

NCS S3060-Y Curry
☀️



NCS S4050-B40G
Water blue
(Available while stocks last)
☀️

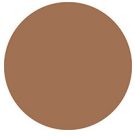

NCS S 5030-Y70R
Terracotta
☀️



NCS S4040-R
Marsala
(Available while stocks last)
☀️



NCS S6030-B
Capri blue
☀️



NCS S3010-G50Y
Pistachio
(available while stocks last)
☀️



NCS S7020-G50Y
Olive green
☀️

TE FABRICS

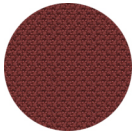

Alba
+ 8 colors



Aragon
+ 14 colors



Melva
+ 5 colors



Fortis + 8 colori



Roccia
+ 8 colors



Amsterdam
+ 8 colors

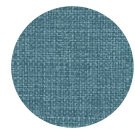

Medley Gabriel
+ 15 colors

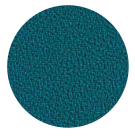

Mirage
+ 8 colors

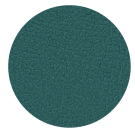

Inca
+ 14 colors

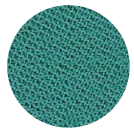

Chili Gabriel
+ 8 colors



Convert
+ 7 colors



Fenice
+ 8 colors



Mood Gabriel
+ 8 colors



Valencia
+ 14 colors

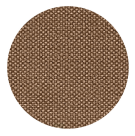

Reviva Hero
+ 10 colors
☀️



Fabthirty Rubelli
+ 8 colors
☀️

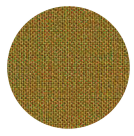

Remix 3 Kvadrat
+ 15 colors



Ocean Mastrotto
+ 15 colors

NOTE

Resources

3ds



dwg



Notes

Shells in **olive green** and **marsala** are made of **100% recycled polypropylene** from industrial waste.

FRAMES

AC STEEL



NCS s0502-b VR Traffic white
☀



NCS S0500-N VR Pure white
☀



VR Pewter
☀



NCS S4000-N VR White aluminium
☀



RAL 7016 Anthracite grey
☀



NCS S9000-N VR Jet black
☀



NCS S9000-N VR Matt Jet Black
☀



NCS S8005-Y20R Brown
☀



VR Rough metallic bronze
☀



NCS S4040-R Marsala
☀



CR Chrome

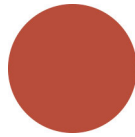

NCS S3060-Y80R Coral red
☀

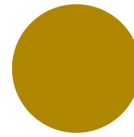

NCS S3060-Y Curry
☀



NCS S7020-G50Y Olive green
☀



NCS S4050-B40G Water blue
☀



NCS S6030-B Capri blue
☀

USES

coffee & restaurants, hotels, educational, office and waiting areas, retail, Residenziale,

Snap 1103

SNAP COLLECTION:

Snap 1100, Snap 1100n, Snap 1101, Snap 1101n, Snap 1102, Snap 1102b, Snap 1103, Snap 1105, Snap 1105N, Snap 1106, Snap 1106N, Snap 1108, Snap 1109, Snap 1108N, Snap 1109N,

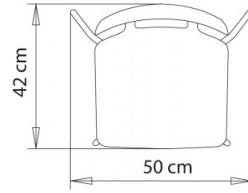
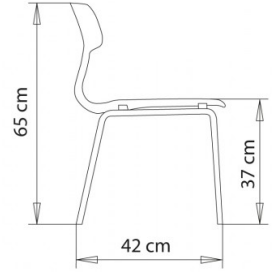
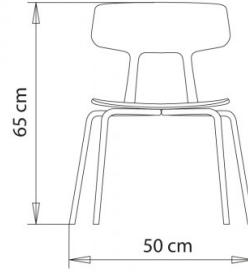

Baby chair with 4 legs steel frame.

WEIGHT

2,7 Kg

PACK

0,34 m³

PIECES PER BOX

4

FINISHES SEATING

PP POLYPROPYLENE

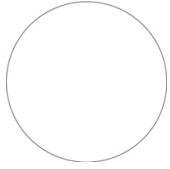

NCS S0502-B
Traffic white
☀️



NCS S 2005-G90Y
Hemp white
☀️

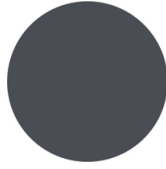

NCS S7502-B
Anthracite grey
(Available while stocks last)
☀️

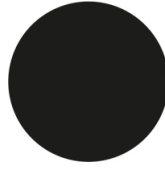

NCS S9000-N
Jet black
☀️

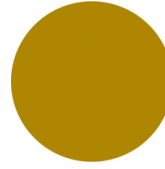

NCS S3060-Y Curry
☀️



NCS S4050-B40G
Water blue
(Available while stocks last)
☀️

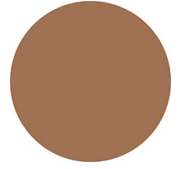

NCS S 5030-Y70R
Terracotta
☀️



NCS S4040-R
Marsala
(Available while stocks last)
☀️

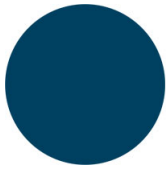

NCS S6030-B
Capri blue
☀️



NCS S7020-G50Y
Olive green
☀️

NOTE

Resources

3ds



dwg



Notes

Shells in **olive green** and **marsala** are made of **100% recycled polypropylene** from industrial waste.

FRAMES

AC STEEL



NCS s0502-b VR Traffic
white
☀️



NCS S0500-N VR Pure
white
☀️



VR Pewter
☀️



NCS S4000-N VR
White aluminium
☀️



RAL 7016 Anthracite
grey
☀️



NCS S9000-N VR Jet
black
☀️



NCS S9000-N VR
Matt Jet Black
☀️



NCS S8005-Y20R
Brown
☀️



VR Rough metallic
bronze
☀️

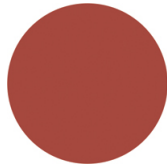

NCS S4040-R
Marsala
☀️



CR Chrome

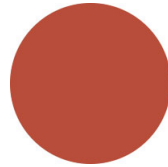

NCS S3060-Y80R
Coral red
☀️

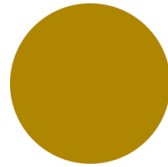

NCS S3060-Y Curry
☀️



NCS S7020-G50Y
Olive green
☀️



NCS S4050-B40G
Water blue
☀️

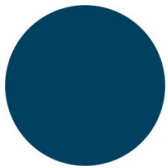

NCS S6030-B
Capri blue
☀️

USES

hotels, educational, retail, outdoor,

Snap 1105

SNAP COLLECTION:

Snap 1100, Snap 1100n, Snap 1101, Snap 1101n, Snap 1102, Snap 1102b, Snap 1103, Snap 1105, Snap 1105N, Snap 1106, Snap 1106N, Snap 1108, Snap 1109, Snap 1108N, Snap 1109N,

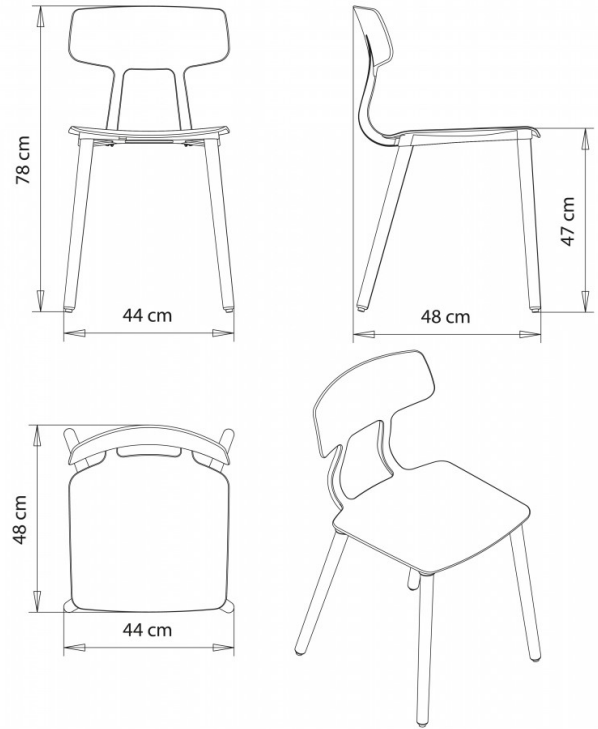

Chair, 4-leg wooden frame and cast aluminium.



The wooden frames of the Snap collection are FSC® certified.

WEIGHT

4 Kg

PACK

0,31 m³

PIECES PER BOX

2

FINISHES SEATING

PP POLYPROPYLENE

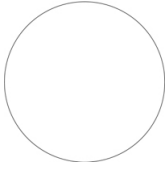

NCS S0502-B
Traffic white



NCS S 2005-G90Y
Hemp white



NCS S4005-B20G
Squirrel grey
(available while stocks last)

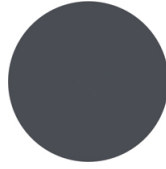

NCS S7502-B
Anthracite grey
(Available while stocks last)

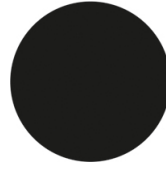

NCS S9000-N
Jet black

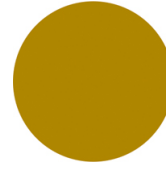

NCS S3060-Y Curry



NCS S4050-B40G
Water blue
(Available while stocks last)

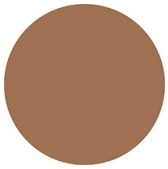

NCS S 5030-Y70R
Terracotta

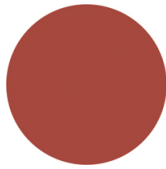

NCS S4040-R
Marsala
(Available while stocks last)

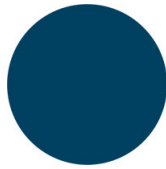

NCS S6030-B
Capri blue



NCS S7020-G50Y
Olive green



NOTE

Resources

3ds | dwg

Notes

Shells in **olive green** and **marsala** are made of **100% recycled polypropylene** from industrial waste.

FRAMES

LE WOOD



Beech | Honey stained



Beech | Chesnut stained



Beech | Grey stained



Beech | Dark brown stained

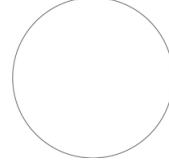

Beech | Stained according to sample



beech | Black stained

USES

coffee & restaurants, hotels, entertainment, travel, retail,

Snap 1105N

SNAP COLLECTION:

Snap 1100, Snap 1100n, Snap 1101, Snap 1101n, Snap 1102, Snap 1102b, Snap 1103, Snap 1105, Snap 1105N, Snap 1106, Snap 1106N, Snap 1108, Snap 1109, Snap 1108N, Snap 1109N,

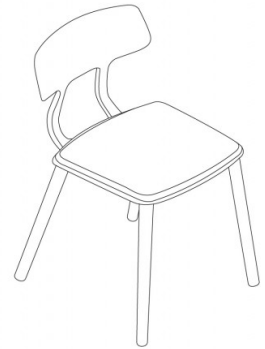
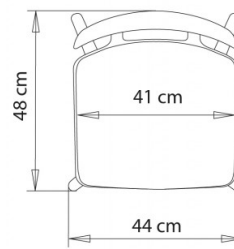
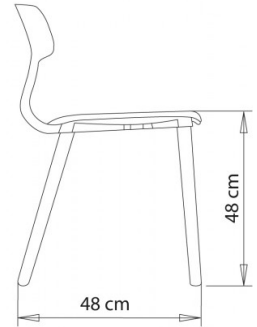
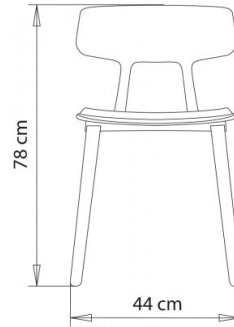

Chair with 4 legs wooden frame and cast aluminium. Upholstered seat.

WEIGHT

4 Kg

PACK

0,34 m³

PIECES PER BOX

1

FINISHES SEATING

PP POLYPROPYLENE

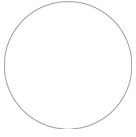

NCS S0502-B
Traffic white
☀️



NCS S 2005-G90Y
Hemp white
☀️



NCS S4005-B20G
Squirrel grey
(available while stocks last)
☀️



NCS S7502-B
Anthracite grey
(Available while stocks last)
☀️

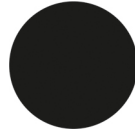

NCS S9000-N
Jet black
☀️

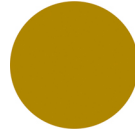

NCS S3060-Y Curry
☀️



NCS S4050-B40G
Water blue
(Available while stocks last)
☀️

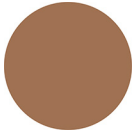

NCS S 5030-Y70R
Terracotta
☀️



NCS S4040-R
Marsala
(Available while stocks last)
☀️

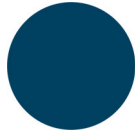

NCS S6030-B
Capri blue
☀️



NCS S7020-G50Y
Olive green
☀️

TE FABRICS

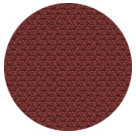

Alba
+ 8 colors



Aragon
+ 14 colors



Melva
+ 5 colors



Fortis + 8 colori



Roccia
+ 8 colors



Amsterdam
+ 8 colors

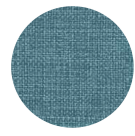

Medley Gabriel
+ 15 colors

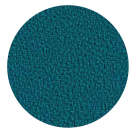

Mirage
+ 8 colors

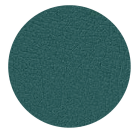

Inca
+ 14 colors

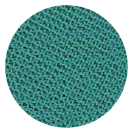

Chili Gabriel
+ 8 colors



Convert
+ 7 colors



Fenice
+ 8 colors



Mood Gabriel
+ 8 colors



Valencia
+ 14 colors

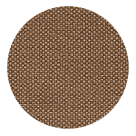

Reviva Hero
+ 10 colors
☀️



Fabthirty Rubelli
+ 8 colors
☀️

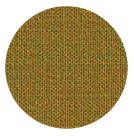

Remix 3 Kvadrat
+ 15 colors



Ocean Mastrotto
+ 15 colors

NOTE

Resources

3ds



dwg



Notes

Shells in **olive green** and **marsala** are made of **100% recycled polypropylene** from industrial waste.

FRAMES

LE WOOD



Beech | Honey stained



Beech | Chesnut stained



Beech | Grey stained



Beech | Dark brown stained

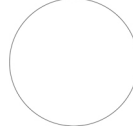

Beech | Stained according to sample



beech | Black stained

USES

coffee & restaurants, hotels, retail, Residenziale,

Snap 1106

SNAP COLLECTION:

Snap 1100, Snap 1100n, Snap 1101, Snap 1101n, Snap 1102, Snap 1102b, Snap 1103, Snap 1105, Snap 1105N, Snap 1106, Snap 1106N, Snap 1108, Snap 1109, Snap 1108N, Snap 1109N,

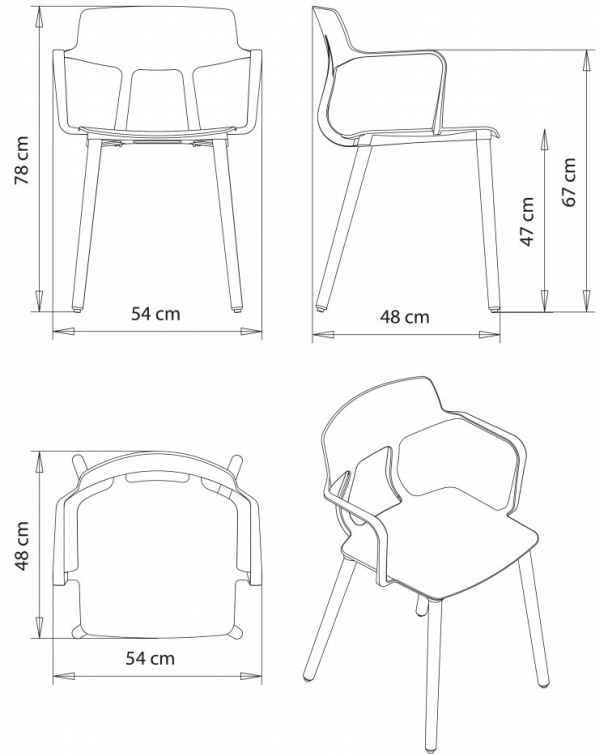

Chair with armrests, 4-leg wooden frame and cast aluminium.



The wooden frames of the Snap collection are FSC® certified.

WEIGHT

4,3 kg

PACK

0,32 m³

PIECES PER BOX

1

FINISHES SEATING

PP POLYPROPYLENE

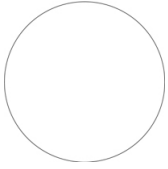

NCS S0502-B
Traffic white
☀️



NCS S 2005-G90Y
Hemp white
☀️



NCS S4005-B20G
Squirrel grey
(available while stocks last)
☀️



NCS S7502-B
Anthracite grey
(Available while stocks last)
☀️

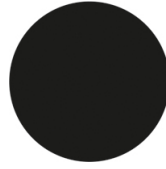

NCS S9000-N
Jet black
☀️

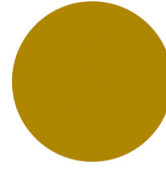

NCS S3060-Y Curry
☀️



NCS S4050-B40G
Water blue
(Available while stocks last)
☀️

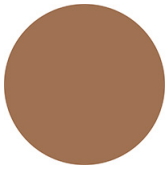

NCS S 5030-Y70R
Terracotta
☀️



NCS S4040-R
Marsala
(Available while stocks last)
☀️

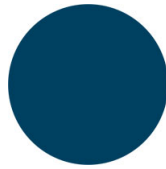

NCS S6030-B
Capri blue
☀️



NCS S3010-G50Y
Pistachio
(available while stocks last)
☀️



NCS S7020-G50Y
Olive green
☀️

NOTE

Resources

3ds | dwg

Notes

Shells in **olive green** and **marsala** are made of **100% recycled polypropylene** from industrial waste.

FRAMES

LE WOOD



Beech | Honey stained



Beech | Chesnut stained



Beech | Grey stained



Beech | Dark brown stained

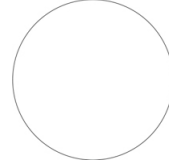

Beech | Stained according to sample



beech | Black stained

USES

coffee & restaurants, hotels, entertainment, travel, retail,

Snap 1106N

SNAP COLLECTION:

Snap 1100, Snap 1100n, Snap 1101, Snap 1101n, Snap 1102, Snap 1102b, Snap 1103, Snap 1105, Snap 1105N, Snap 1106, Snap 1106N, Snap 1108, Snap 1109, Snap 1108N, Snap 1109N,

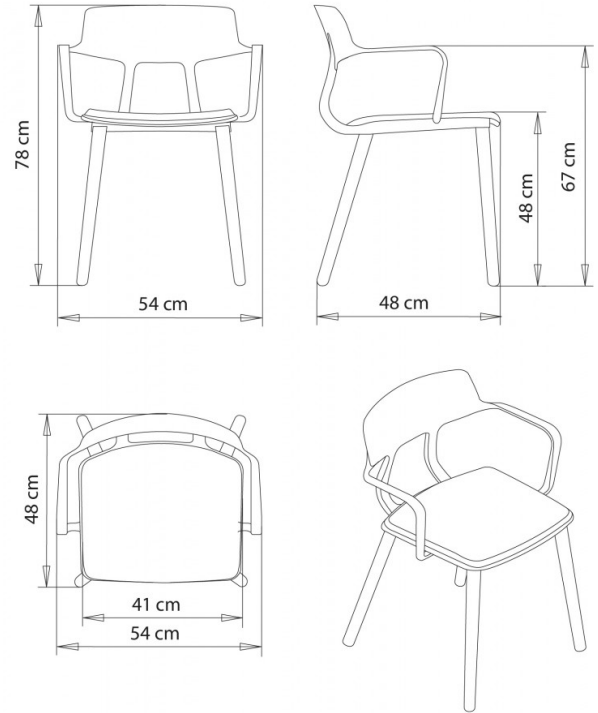

Chair with armrests. 4 legs wooden frame and cast aluminium. Upholstered seat.

WEIGHT

5 Kg

PACK

0,34 m³

PIECES PER BOX

1

FINISHES SEATING

PP POLYPROPYLENE

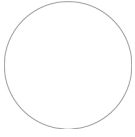

NCS S0502-B
Traffic white
☀️



NCS S 2005-G90Y
Hemp white
☀️



NCS S4005-B20G
Squirrel grey
(available while stocks last)
☀️



NCS S7502-B
Anthracite grey
(Available while stocks last)
☀️



NCS S9000-N
Jet black
☀️

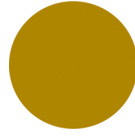

NCS S3060-Y Curry
☀️



NCS S4050-B40G
Water blue
(Available while stocks last)
☀️

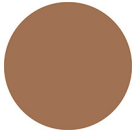

NCS S 5030-Y70R
Terracotta
☀️



NCS S4040-R
Marsala
(Available while stocks last)
☀️



NCS S6030-B
Capri blue
☀️



NCS S3010-G50Y
Pistachio
(available while stocks last)
☀️



NCS S7020-G50Y
Olive green
☀️

TE FABRICS

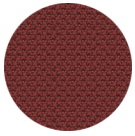

Alba
+ 8 colors



Aragon
+ 14 colors



Melva
+ 5 colors



Fortis + 8 colori



Roccia
+ 8 colors



Amsterdam
+ 8 colors

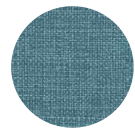

Medley Gabriel
+ 15 colors

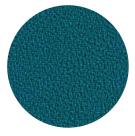

Mirage
+ 8 colors

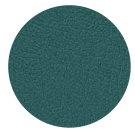

Inca
+ 14 colors

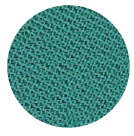

Chili Gabriel
+ 8 colors



Convert
+ 7 colors



Fenice
+ 8 colors



Mood Gabriel
+ 8 colors



Valencia
+ 14 colors

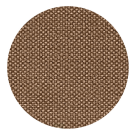

Reviva Hero
+ 10 colors
☀️



Fabthirty Rubelli
+ 8 colors
☀️

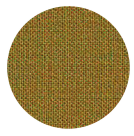

Remix 3 Kvadrat
+ 15 colors



Ocean Mastrotto
+ 15 colors

NOTE

Resources

3ds



dwg



Notes

Shells in **olive green** and **marsala** are made of **100% recycled polypropylene** from industrial waste.

FRAMES

LE WOOD



Beech | Honey stained



Beech | Chesnut stained



Beech | Grey stained



Beech | Dark brown stained

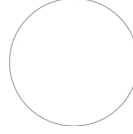

Beech | Stained according to sample



beech | Black stained

USES

coffee & restaurants, hotels, office and waiting areas, retail, Residenziale,

Snap 1108

SNAP COLLECTION:

Snap 1100, Snap 1100n, Snap 1101, Snap 1101n, Snap 1102, Snap 1102b, Snap 1103, Snap 1105, Snap 1105N, Snap 1106, Snap 1106N, Snap 1108, Snap 1109, Snap 1108N, Snap 1109N,

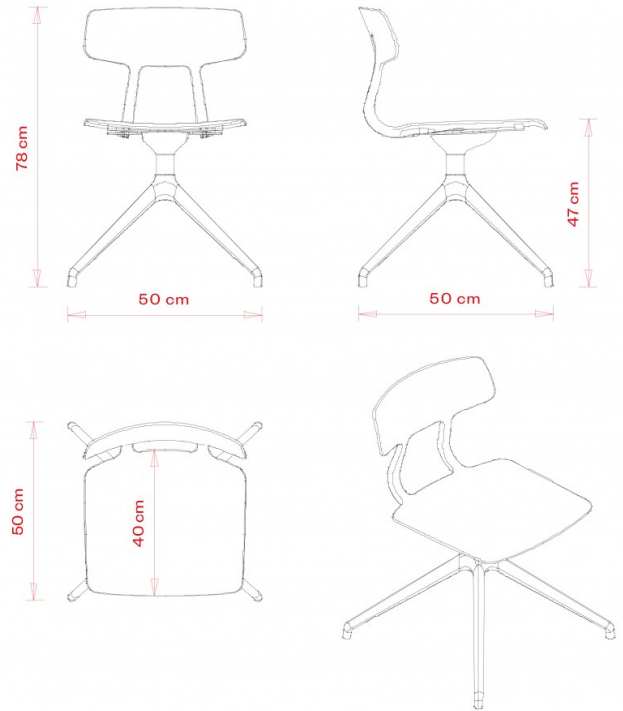

Swivel side chair with 4-star die cast aluminium frame, polypropylene shell.

WEIGHT

6,1 Kg

PACK

0,50 m³

PIECES PER BOX

1

FINISHES SEATING

PP POLYPROPYLENE

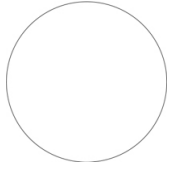

NCS S0502-B
Traffic white



NCS S 2005-G90Y
Hemp white



NCS S4005-B20G
Squirrel grey
(available while stocks last)

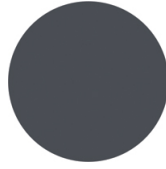

NCS S7502-B
Anthracite grey
(Available while stocks last)

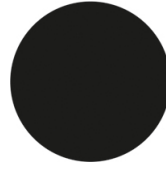

NCS S9000-N
Jet black

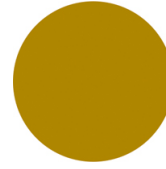

NCS S3060-Y Curry



NCS S4050-B40G
Water blue
(Available while stocks last)

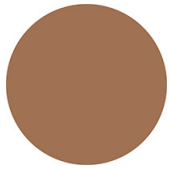

NCS S 5030-Y70R
Terracotta



NCS S4040-R
Marsala
(Available while stocks last)

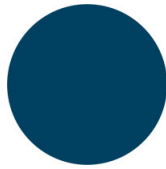

NCS S6030-B
Capri blue



NCS S7020-G50Y
Olive green



NOTE

Resources

3ds



dwg



Notes

Shells in **olive green** and **marsala** are made of **100% recycled polypropylene** from industrial waste.

FRAMES

AL VR

PAINTED ALUMINIUM



NCS S9000-N VR Matt Jet Black



AL PSH

POLISHED ALUMINIUM



Polished aluminium

USES

coffee & restaurants, office and waiting areas, retail,

Snap 1108N

SNAP COLLECTION:

Snap 1100, Snap 1100n, Snap 1101, Snap 1101n, Snap 1102, Snap 1102b, Snap 1103, Snap 1105, Snap 1105N, Snap 1106, Snap 1106N, Snap 1108, Snap 1109, Snap 1108N, Snap 1109N,

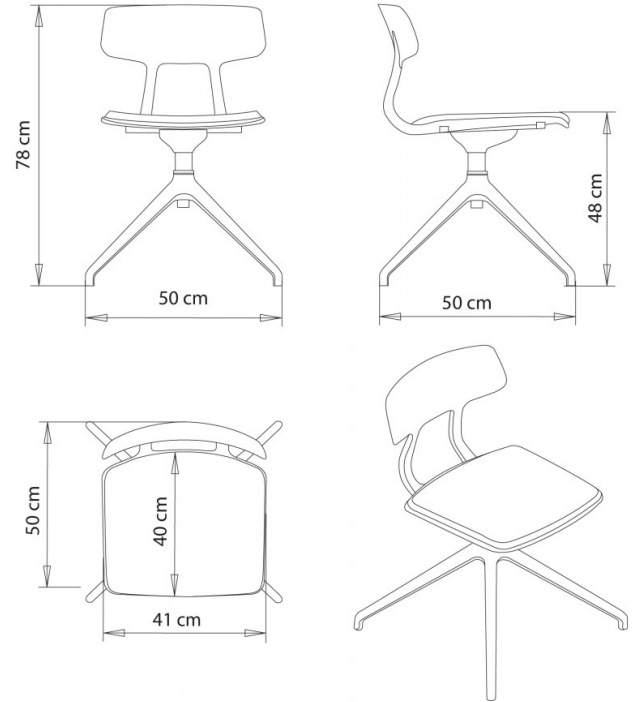

Swivel chair with 4 ways aluminium frame. Upholstered seat.

WEIGHT

6,8 Kg

PACK

0,38 m³

PIECES PER BOX

1

FINISHES SEATING

PP POLYPROPYLENE

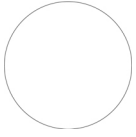

NCS S0502-B
Traffic white
☀️



NCS S 2005-G90Y
Hemp white
☀️



NCS S4005-B20G
Squirrel grey
(available while stocks last)
☀️



NCS S7502-B
Anthracite grey
(Available while stocks last)
☀️

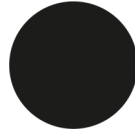

NCS S9000-N
Jet black
☀️

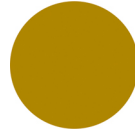

NCS S3060-Y Curry
☀️



NCS S4050-B40G
Water blue
(Available while stocks last)
☀️

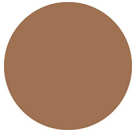

NCS S 5030-Y70R
Terracotta
☀️



NCS S4040-R
Marsala
(Available while stocks last)
☀️

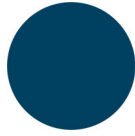

NCS S6030-B
Capri blue
☀️



NCS S7020-G50Y
Olive green
☀️

TE FABRICS

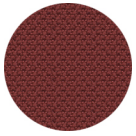

Alba
+ 8 colors



Aragon
+ 14 colors



Melva
+ 5 colors



Fortis + 8 colori



Roccia
+ 8 colors

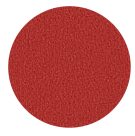

Amsterdam
+ 8 colors

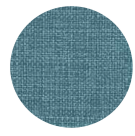

Medley Gabriel
+ 15 colors



Mirage
+ 8 colors

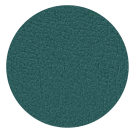

Inca
+ 14 colors

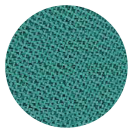

Chili Gabriel
+ 8 colors



Convert
+ 7 colors



Fenice
+ 8 colors



Mood Gabriel
+ 8 colors



Valencia
+ 14 colors

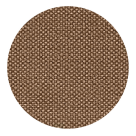

Reviva Hero
+ 10 colors
☀️

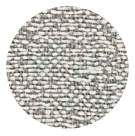

Fabthirty Rubelli
+ 8 colors
☀️

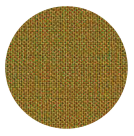

Remix 3 Kvadrat
+ 15 colors



Ocean Mastrotto
+ 15 colors

NOTE

Resources

3ds



dwg



Notes

Shells in **olive green** and **marsala** are made of **100% recycled polypropylene** from industrial waste.

FRAMES

AL VR PAINTED ALUMINIUM



NCS S9000-N VR Matt Jet Black



AL PSH POLISHED ALUMINIUM



Polished aluminium

USES

coffee & restaurants, hotels, office and waiting areas, retail, Residenziale,

Snap 1109N

SNAP COLLECTION:

Snap 1100, Snap 1100n, Snap 1101, Snap 1101n, Snap 1102, Snap 1102b, Snap 1103, Snap 1105, Snap 1105N, Snap 1106, Snap 1106N, Snap 1108, Snap 1109, Snap 1108N, Snap 1109N,

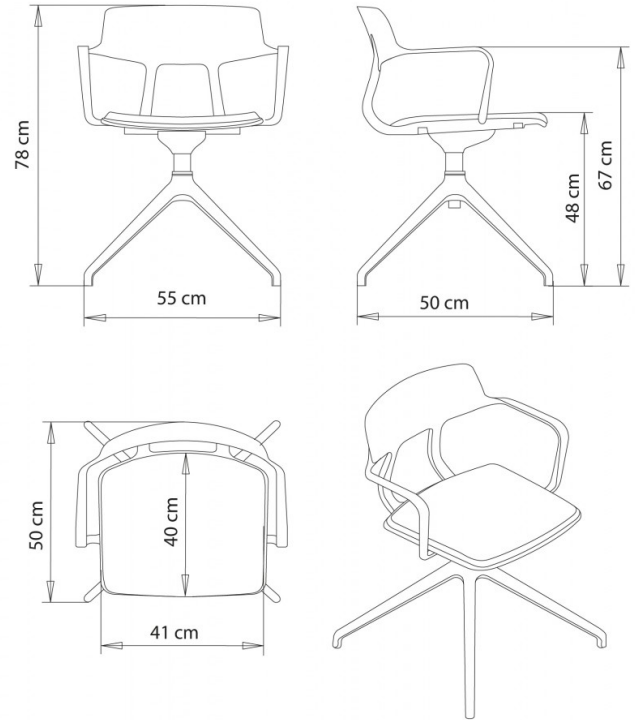

Swivel chair with armrests and 4 ways aluminium frame. Adjustable height.

WEIGHT

7,1 Kg

PACK

0,38 m³

PIECES PER BOX

1

FINISHES SEATING

PP POLYPROPYLENE

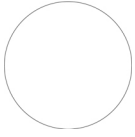

NCS S0502-B
Traffic white
☀️



NCS S 2005-G90Y
Hemp white
☀️



NCS S4005-B20G
Squirrel grey
(available while stocks last)
☀️



NCS S7502-B
Anthracite grey
(Available while stocks last)
☀️

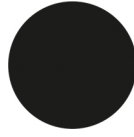

NCS S9000-N
Jet black
☀️

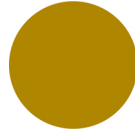

NCS S3060-Y Curry
☀️



NCS S4050-B40G
Water blue
(Available while stocks last)
☀️

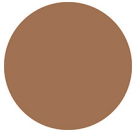

NCS S 5030-Y70R
Terracotta
☀️



NCS S4040-R
Marsala
(Available while stocks last)
☀️



NCS S6030-B
Capri blue
☀️



NCS S3010-G50Y
Pistachio
(available while stocks last)
☀️



NCS S7020-G50Y
Olive green
☀️

TE FABRICS

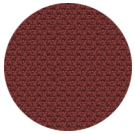

Alba
+ 8 colors



Aragon
+ 14 colors



Melva
+ 5 colors



Fortis + 8 colori



Roccia
+ 8 colors



Amsterdam
+ 8 colors

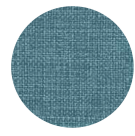

Medley Gabriel
+ 15 colors



Mirage
+ 8 colors

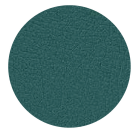

Inca
+ 14 colors

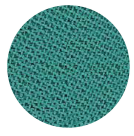

Chili Gabriel
+ 8 colors



Convert
+ 7 colors



Fenice
+ 8 colors



Mood Gabriel
+ 8 colors



Valencia
+ 14 colors

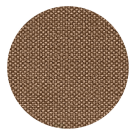

Reviva Hero
+ 10 colors
☀️



Fabthirty Rubelli
+ 8 colors
☀️

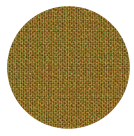

Remix 3 Kvadrat
+ 15 colors



Ocean Mastrotto
+ 15 colors

NOTE

Resources

3ds



dwg



Notes

Shells in **olive green** and **marsala** are made of **100% recycled polypropylene** from industrial waste.

FRAMES

AL VR PAINTED ALUMINIUM



NCS S9000-N VR Matt Jet Black



AL PSH POLISHED ALUMINIUM



Polished aluminium

USES

coffee & restaurants, hotels, office and waiting areas, retail, Residenziale,