

Array sofa system

1

Snøhetta

2024

Array is a sofa system designed by Snøhetta to offer maximum flexibility and comfort. It's a new approach to sofa design and construction, and its goals are reducing environmental impact, achieving customised living solutions, and simplifying logistics. To this end, it introduces small modules that are easy to transport and make it possible to form a variety of layouts. They can also be easily disassembled and reassembled for replacement or recycling. The concept of comfort extends throughout the entire supply chain, moving beyond its ergonomic component. The Array collection is developed from both a micro and macro perspective, and it is suitable for residential and contract contexts.

Structure

The structure is made from an injection moulded base in recycled polypropylene. The process leaves a hollow cavity in the centre in order to use as little material as possible.

The seat and backrest are moulded in Bio polyurethane foam, and designed to maximise comfort.

The hidden fastening system is made of glass-filled nylon.

Upholstery

The upholstery is made to enhance softness, and cover every part of the sofa. It is also completely removable. The fabric cover is also available in recycled polyester.

It is possible to purchasing an additional cover upholstery.

Modules

The system includes the following modules:

- straight module with backrest L32 D96 H68
- module for external curve L40 D96 H68
- module for inside curve L40 D96 H68
- straight pouf module L32 D96 H40
- curved pouf module L40 D96 H40.

Accessories

The Array system is completed with three coffee tables in wood with veneer in the finishes bleached oak, brown oak and canaletto walnut.

Available in two variants:

- Freestanding coffee table, dimensions L32 D32 H44, L45 D45 H39 and L32 D74 H34;
- Side table to be inserted between the padded modules, size L23 D52 H23.



PLEASE NOTE

TO SELECT A SUITABLE FABRIC FOR EACH PRODUCT, PLEASE REFER TO THE TECHNICAL SECTION AT THE END OF THE PRICE LIST OR TO THE PRODUCT SHEETS AVAILABLE IN THE WEBSITE.
CUSTOMER'S FABRIC: FEASIBILITY, PRICES AND DELIVERY TIMES ARE TO BE AGREED AND VERIFIED WITH THE SALES DEPARTMENT.

FLAME RETARDANT PADDING

NORMS 11M, U.S.A. TB117-2021 AND BS5852 ARE AVAILABLE UPON REQUEST WITH A SURCHARGE AS OF +5%. FEASIBILITY, COSTS AND DELIVERY TIMES TO BE VERIFIED WITH OUR SALES DEPARTMENT.
NB: THE USE OF FLAME RETARDANT POLYURETHANES AND INTERLINER CAN GIVE A DIFFERENT RESULT FROM THE STANDARD.
FOR THE CHOICE OF THE UPHOLSTERY AND ITS FEASIBILITY ACCORDING TO ANY NORMS, PLEASE REFER TO THE TECHNICAL SECTION AT THE END OF THIS PRICE LIST.



Array sofa system

1

Abacus

straight module with backrest

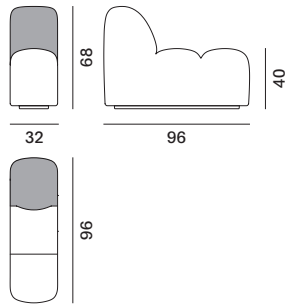

module for external curve

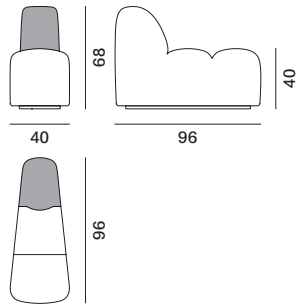

module for inside curve

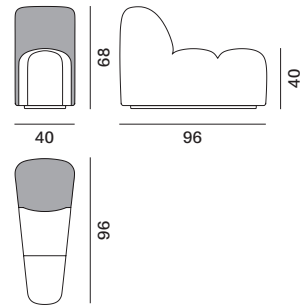

straight pouf module

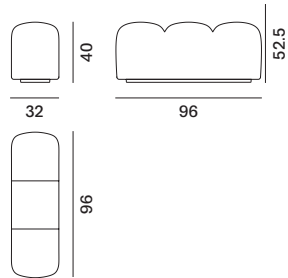

curved pouf module

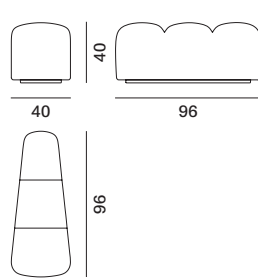

coffee tables

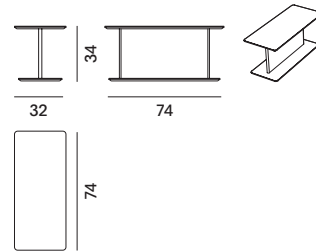
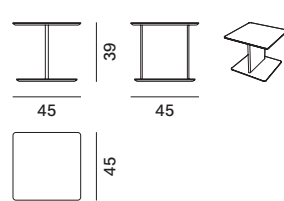
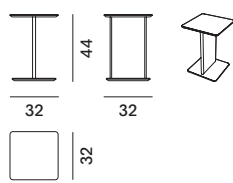

side table

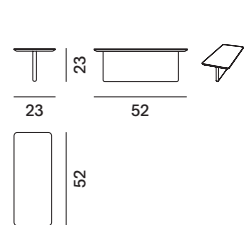

Array sofa system

1

examples of compositions

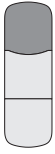

straight module with backrest

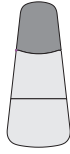

module for external curve

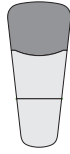

module for inside curve



straight pouf module



curved pouf module

COMPOSITION A

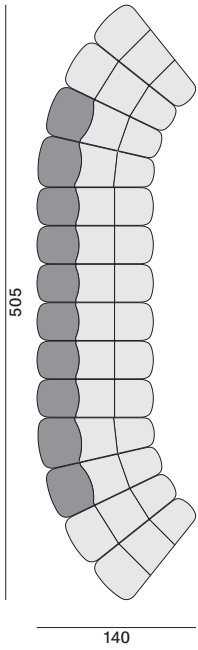

COMPOSITION B

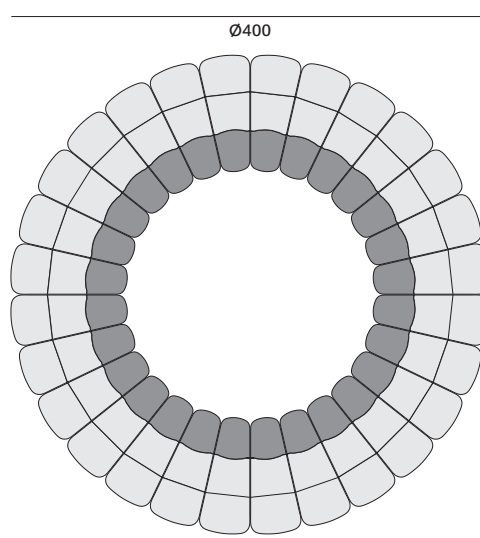

COMPOSITION C

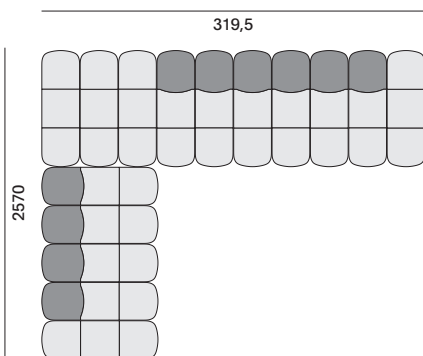

COMPOSITION D

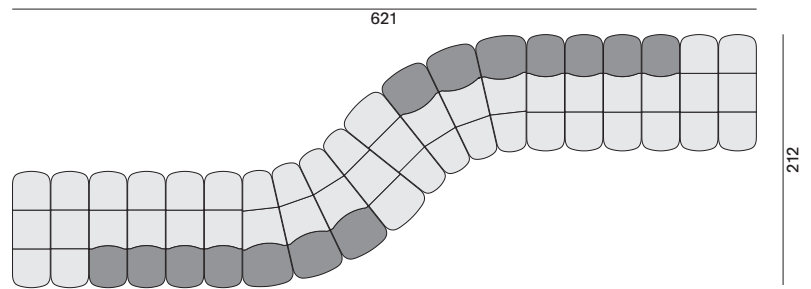

Array sofa system

1

examples of compositions

COMPOSITION E

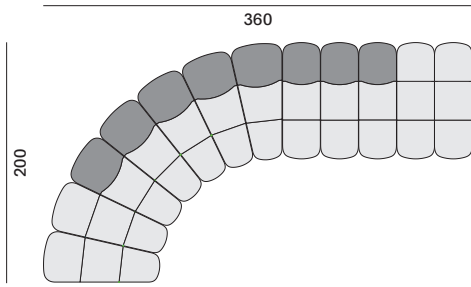

COMPOSITION F

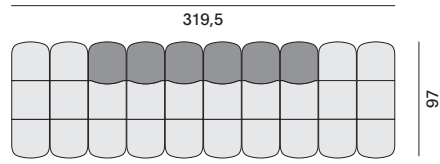

COMPOSIZIONE G

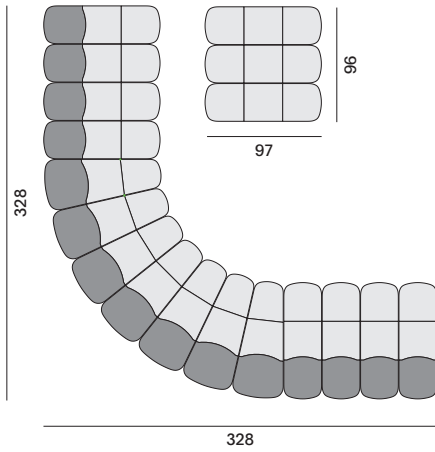

COMPOSITION H

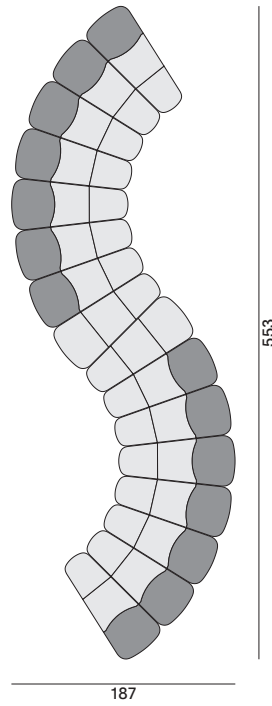

COMPOSITION I

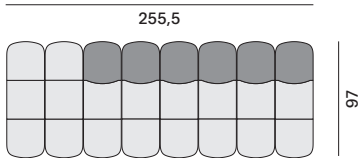

COMPOSITION L

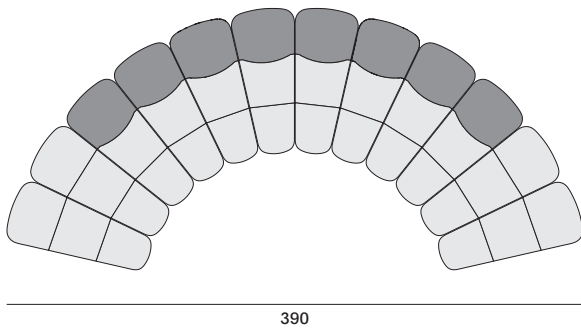

COMPOSITION M

